

Model 0390



EZFILL™ KIT*

EZFILL™ TOP FILL MULTIFEED KIT
WITH 1.32 GAL. (5L) CONTAINER

INSTALLATION AND MAINTENANCE GUIDE

Space Provided For Owner Notes

TABLE OF CONTENTS

3	PRE-INSTALLATION INFORMATION
4	PACK CONTENTS
5-6	TECHNICAL DATA
7	INSTALLATION
8	FILLING THE SOAP TANK
9	MAINTENANCE
9	TROUBLESHOOTING
9	SPARE PARTS LIST
10	WARRANTY

PRE-INSTALLATION INFORMATION

CHECK CONTENTS

Separate all parts from the packaging and check each part with the PACK CONTENTS section.

Make sure all parts are received and separated before discarding any packaging material.

If any parts are missing, do not attempt to install the system until you obtain the missing parts.

IMPORTANT

Ensure there is adequate space and clearance under the vanity to accommodate the tank in the desired location before drilling the hole in the counter top.

Ensure there is adequate space to place the Tank and Support Bracket within reach of the Fill Hose from the Top Fill Port.

PACK CONTENTS

EZFILL™ TOP FILL MULTIFEED KIT 0390

Identify the items and confirm that parts are included.

ITEMS		
No	Name	Q
1	Fill Port	1
2	Cover, Fill Port	1
3	Washer, Rubber	1
4	Washer, SS	1
5	Nut, M32	1
6	Hose	1
7	Coupling Cap	1
8	Blank Plug	6
9	O-Ring, 8	6
10	Bushing	6
11	O-Ring, 50.5	1
12	O-Ring, 50.5	1
13	Tank, 5L (169 oz)	1
14	Hex Key, 6mm	1
15	O-Ring, 36	1

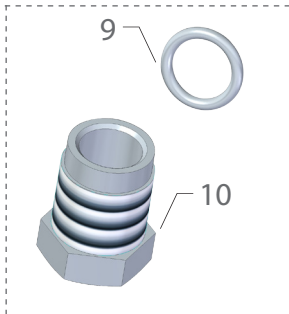
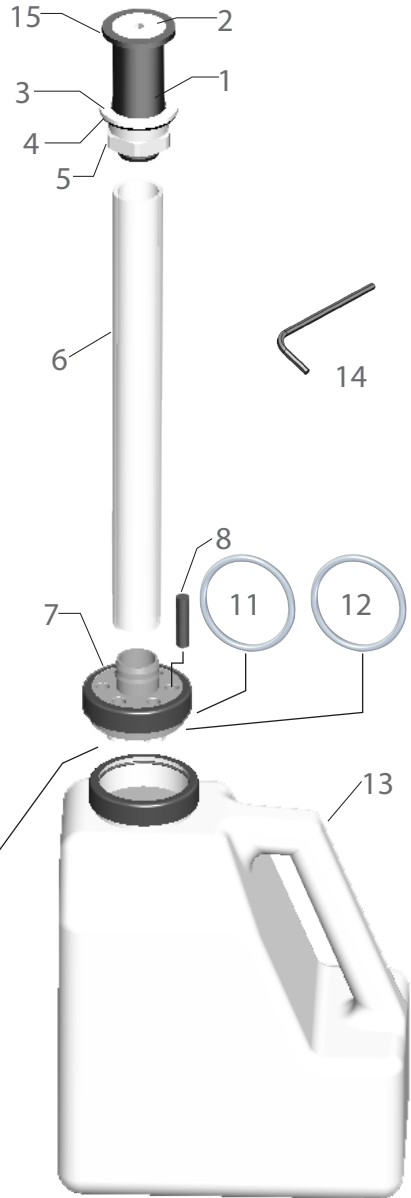

TECHNICAL DATA

FILL PORT DETAIL

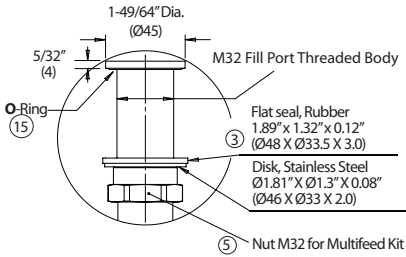

Recommended hole size
 1-5/16" Dia. (Ø33.4)
 min 1-9/32" Dia (Ø32.5)
 max 1-3/8" Dia (Ø34.9)

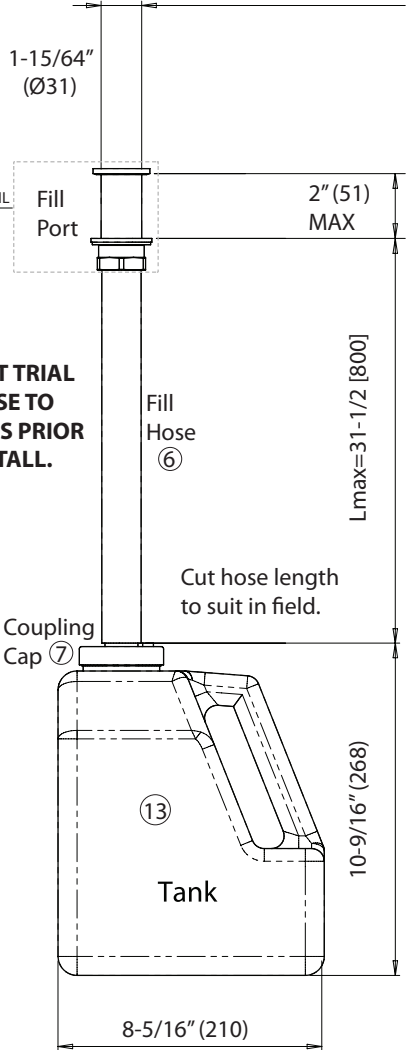

**DO NOT TRIAL
 FIT HOSE TO
 NIPPLES PRIOR
 TO INSTALL.**

Capacity	1.32 gal {169 oz} (5L)
Soap consistency	Smooth liquid, NO Abrasives
Soap viscosity	100 – 3800 cPs (MPa·s)
Soap pH	Range: 5-9
Fill hose and supply tube capacity	Varies per Length*
RECOMMENDED HOLE SIZE:	
Top fill port	1-5/16" Dia. (Ø33.4)

* Hose= Approx. 0.5 Oz/in. (14.54 ml/25mm)
 * Supply Tubes= Approx. 0.02 Oz/in. (0.58 ml/25mm)

All Dim's inch (mm) NTS

TECHNICAL DATA

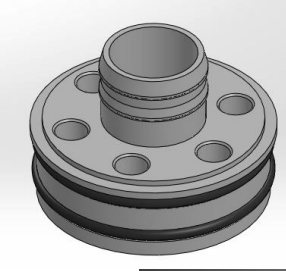

Coupling Cap
(See item 7)

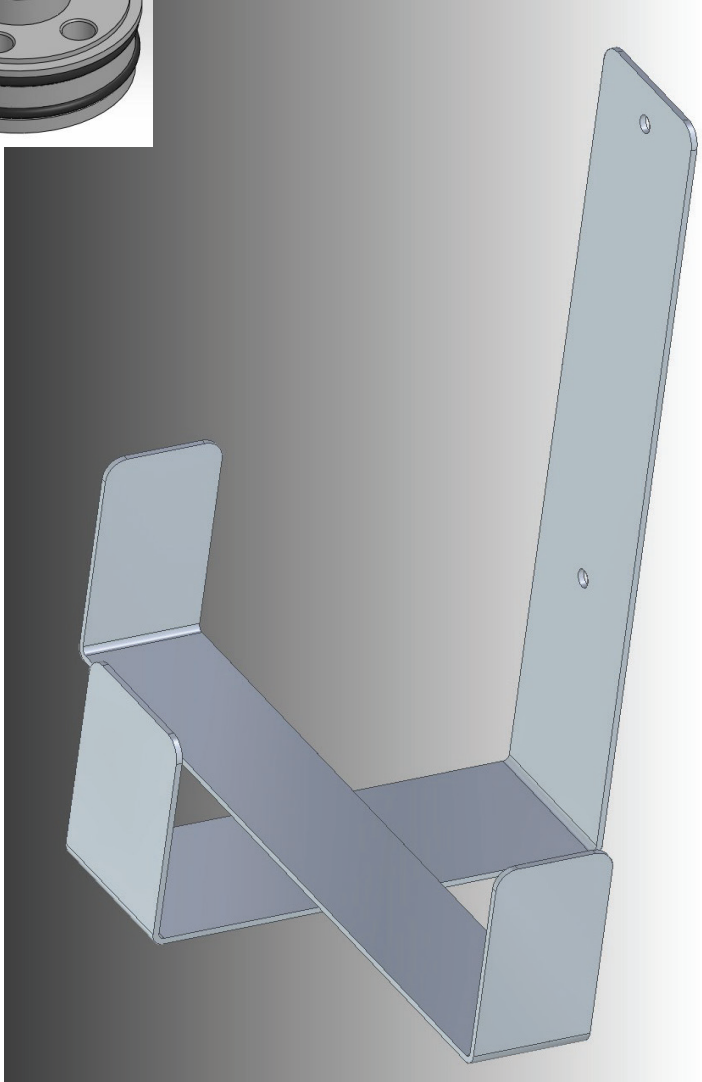

Optional Tank Mounting Bracket 0390-BR

INSTALLATION

Install the soap fill hose onto the fill port nipple **ONLY AFTER THE FILL PORT IS INSTALLED.**

Cut the soap fill hose to the right length as required by the installation **PRIOR TO INSTALLATION.**

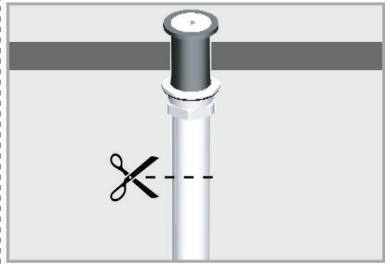

Soap fill hose is provided attached to the soap tank coupling cap nipple. **DO NOT REMOVE.**

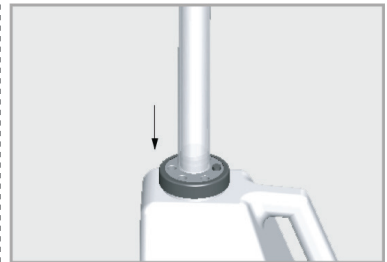

See 0390-(n) installation for soap supply tubes, install through the locking bushings in the soap tank cap to reach to approximately 1/2" (13) above the bottom of the tank.

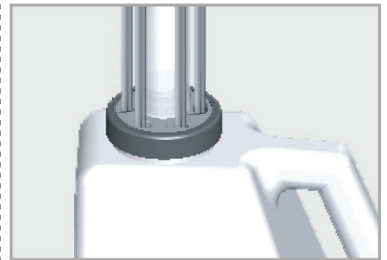

NOTE: The Multifeed Kit enables soap distribution for up to six (6) soap dispensers simultaneously. When installing less than a full complement of soap dispensers, make sure to insert and clamp the 5/16" dia x 1" long (Ø8x25) plugs into the remaining empty holes provided.

FILLING THE SOAP TANK

STEP 1- FILLING THE SOAP TANK

- 1 Open the top filling cap using the hex key provided.

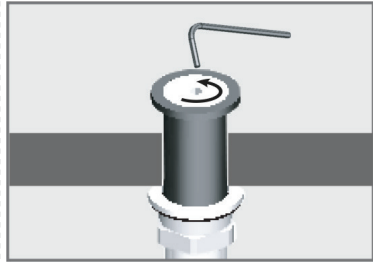

- 2 Fill the soap tank with liquid soap until it is full. Refer to 'Technical Data' section of this manual for soap specifications. (Page 5)

Close the cap after filling.

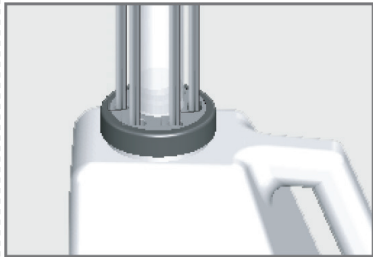

STEP 2- PRIMING THE SOAP DISPENSER

SEE THE 0390-(n) OM & IG for instructions to push the prime button on the pump motor or use the "FILL" button on the remote control 0390-R.

MAINTENANCE

Care and cleaning of chrome and special finishes- see also PCM document.

DO NOT use steel wool or cleansing agents containing alcohol, acid, abrasives, or the like. Use of any cleaning or maintenance products containing these substances could damage the surface of the fill port. For surface cleaning use ONLY soap and water, then wipe dry with a clean cloth or towel. When cleaning bathroom tiles or counters, protect the fill port from any splattering of harsh cleansers.

TROUBLESHOOTING

PROBLEM	INDICATOR	CAUSE	SOLUTION
SOAP LEAKS AT FILL PORT	Soap Residue	Poor hose connection	Cut off and reinstall correctly
SOAP LEAKS AT TANK CAP	Soap residue on tank cap	Loose fill hose	Reset or cut off and reinstall
	Soap residue on tank	Loose blank plugs	Insert completely
		Loose cap locking ring	Ensure completely tightened
SOAP LEAKS ON FLOOR	Puddle of soap on floor	O-Rings damaged or missing	Replace as required
		Damaged tank	Replace tank

SPARE PARTS LIST

Bracket for EZFILL™ Multi Feed Tank	0390-BR
EZFILL™ 5-Liter Plastic Container	0390-SCON
EZFILL™ Disc Cover for Top-Fill Tube	0390-TMC

WARRANTY

We are pleased to offer this warranty covering ASI products furnished for your project.

This warranty replaces any other warranties or product descriptions, whether expressed or implied, written or oral.

It is understood that the products for this project have been selected and inspected by the purchaser, and have been accepted without qualification by the purchaser as merchantable, fit for the intended use, and satisfy the specifications.

THESE ASI PRODUCTS ARE WARRANTED TO BE FREE OF DEFECTS IN MATERIAL OR WORKMANSHIP FOR A PERIOD OF ONE (1) YEAR FROM DATE OF INVOICE.

BABY CHANGING STATIONS, IF INCLUDED ON THIS PROJECT, ARE WARRANTED TO BE FREE OF DEFECTS IN MATERIAL OR WORKMANSHIP FOR A PERIOD OF FIVE (5) YEARS FROM DATE OF INVOICE.

MIRRORS, IF INCLUDED ON THIS PROJECT, ARE WARRANTED AGAINST SILVER SPOILAGE UNDER NORMAL INDOOR ATMOSPHERIC CONDITIONS FOR A PERIOD OF FIFTEEN (15) YEARS FROM DATE OF INVOICE.

DRYER MODELS IF INCLUDED ON THIS PROJECT ARE WARRANTED TO BE FREE OF DEFECTS IN MATERIAL OR WORKMANSHIP FOR A PERIOD BETWEEN FIVE (5) AND TEN (10) YEARS, FROM DATE OF INVOICE. PLEASE REFER TO INDIVIDUAL TECHNICAL DATA SHEET FOR DRYER WARRANTY.

EZ FILL™ SOAP DISPENSER WILL BE FREE OF DEFECTS IN MATERIAL AND WORKMANSHIP DURING NORMAL USE FOR (2) TWO YEARS FROM THE DATE OF INVOICE.

Should the product fail under this warranty, the sole remedy, at the seller's option, will be to repair the defective product, refund the purchase price, provide an equivalent new or refurbished product or provide parts only.

ASI AND/OR SELLER DISCLAIM ANY LIABILITY FOR SPECIAL, INCIDENTAL OR CONSEQUENTIAL DAMAGES. This warranty excludes product damage due to incorrect installation, improper maintenance, wear and tear, battery spoilage, product abuse, or product misuse, whether performed by a contractor, service company, or the consumer.

ASI will not be responsible for labor costs associated with the removal, replacement, repair by others, reinstallation, renovation or return of its products.

ASI[®]



RoHS