



**AMERICAN SPECIALTIES, INC.**  
441 Saw Mill River Road, NY 10701  
(914) 476.9000 • (914) 476.0688  
www.americanspecialties.com

**MODEL №: 0533-48**

ISSUED: 01/87

REVISED: 10/11

## SURFACE MOUNTED CORNER GUARD

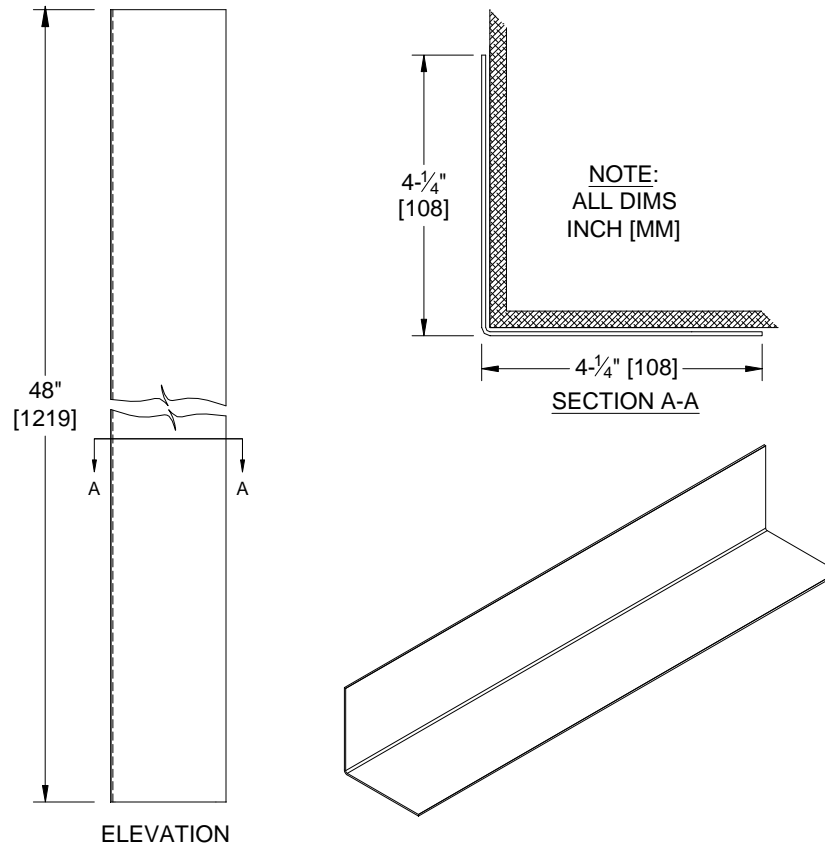

### SPECIFICATION

Surface Mounted Outside Corner Guard shall be 18 gauge type 304 alloy 18-8 stainless steel with a 1/8" (3.2) radius outside edge. Width of guard on each side shall be 4-1/4" (108) x 48" long (1219). All exposed edges shall be smooth and fully debarred. Back surface shall be rough textured to facilitate adherence to wall surface. All exposed surfaces shall be satin finish and be protected during shipment with a PVC film easily removable after installation.

**Surface Mounted Outside Corner Guard shall be Model № 0533-40 as fabricated by American Specialties Inc., 441 Saw Mill River Road, Yonkers, New York 10701-4913**

### INSTALLATION

Unit is surface mounted on finished wall by applying adhesive (by others) to back of guard and wall as per mastic manufacturers recommendations. Guard can be mounted flush to floor or at base height when bull-nose floor base is used.