

Flanges for Shower Curtain Rod, End Flanges (Pair)

Shower/Tub Accessories

MasterFormat Section 10 28 13

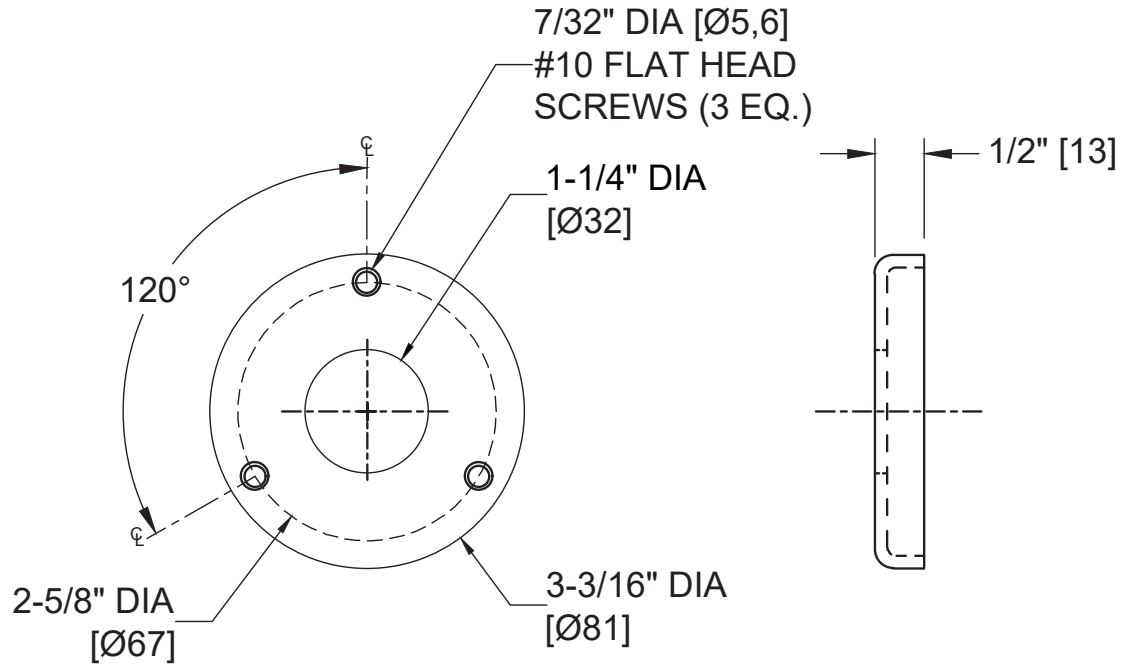

Scan for
Information



SUSTAINABILITY/LEED

MR 4.1 (1) MR 6 (1) EQ 4.2 (1)
MR 4.2 (1) EQ 4.1 (1) EQ 4.4 (1)

NOTE:
ALL DIM'S INCH [MM]
ILLUSTRATION FOR REF ONLY AND NTS

PRODUCT OVERVIEW

Flanges fabricated of 20ga. stainless steel with a satin finish. Flanges have (3) countersunk 13/64" diameter [Ø5] holes to accept #10 flat or oval head screws furnished by others. Rod is installed in straight section between two (2) mounting flanges. Rods longer than 72" [1829] require ceiling hanger Model #1204-C18. For use with standard shower curtain Model #1200 or #1200-V having 72" [1829] length and standard hooks Model #1200-SHU unit should be installed with rod centerline 74-1/2" [1892] AFF or 67" [1702] above tub rim to obtain 6" [152] bottom overlap.

KEY FEATURES & SPECIFICATIONS

- Designed to accept 1-1/4" Dia. [Ø32] rod
- Countersunk holes accept flathead screws
- Type 304 Stainless Steel - Bright Finish
- 18 gauge Thick Material
- Surface Mounted

OPERATION & MAINTENANCE

Rod is held captive by flanges when installed properly. Rod may rotate in flanges if turned by hand. Correctly installed rod and flanges will support specified shower curtain(s) hung on hooks 1200-SHU or others (by others). Rod will bend and pull from flanges if significant body weight is suspended.

TECHNICAL INFORMATION / PRODUCT PROPERTIES

Property	Value
Dimensions	3-3/16" [Ø81] Diameter flange x 1-1/4" Dia. Rod [Ø32] x 1/2" [13]
Construction	Type 304 Stainless Steel - Bright Finish 18 gauge Thick Material
Mounting	Surface Mounted
Materials	<u>20 gauge (.0356" [0.9] thick) type 304 stainless steel. Exposed surfaces are satin finish. Edges and corners are radiused and burr free.</u>

INSTALLATION

Rod is installed in straight section between two (2) mounting flanges. Rods longer than 72" [1829] require ceiling hanger Model #1204-C. For use with standard shower curtain model #1200 or #1200-V having 72" [1829] length and standard hooks Model #1200-SHU unit should be installed with rod centerline 74-1/2" [1892] AFF or 67" [1702] above tub rim to obtain 6" [152] bottom overlap.

ADDITIONAL INFORMATION
WARRANTY

One (1) Year from date of Invoice