

1-1/2" Dia. Snap Flange Grab Bar - 24" [610] Length – Matte Black Powder Coated

Grab Bars

MasterFormat Section 10 28 13

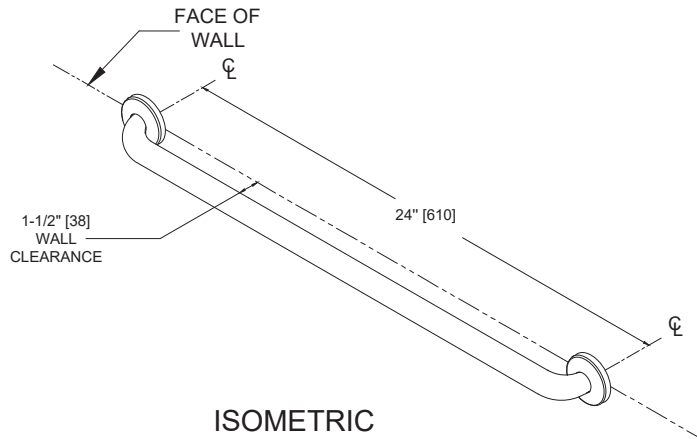
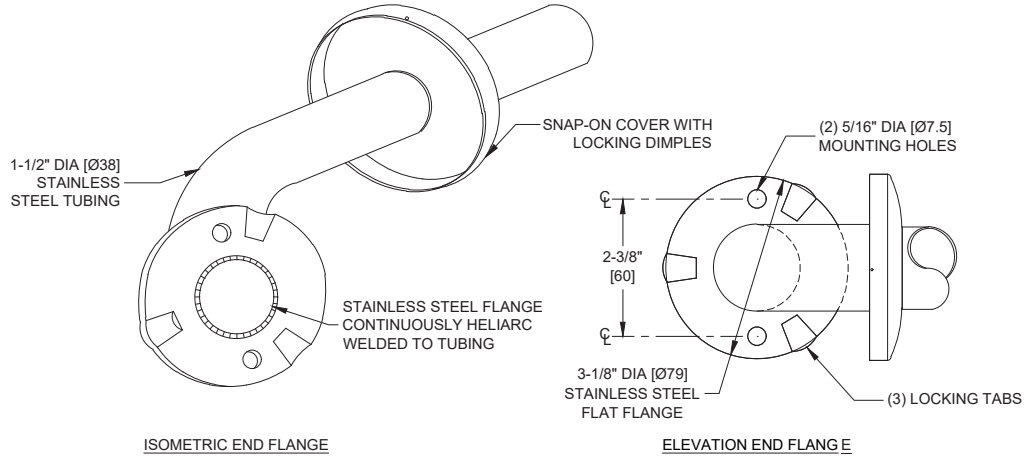

NOTE:
ALL DIM'S INCH [MM]
ILLUSTRATION FOR REF ONLY AND NTS

Scan for Information



SUSTAINABILITY/LEED

MR 4.1 (1) MR 6 (1) EQ 4.2 (1)
MR 4.2 (1) EQ 4.1 (1) EQ 4.4 (1)

PRODUCT OVERVIEW

Features include cover that snaps over mounting flange dimples to conceal screws and concealed mounting flange of 3-1/8" [79] O.D. with 2 screw holes and 3 locking dimples; 1/8" [3] thick, type 304 stainless steel. Cover is type 304 stainless steel with a Matte Black Powder Coated finish and 22 gauge, 3-3/16" [81] diameter. 1-1/2" O.D [Ø38] horizontal grab bar with a smooth surface.

KEY FEATURES & SPECIFICATIONS

- Straight Grab Bar
- Snap Flange - cover snaps over mounting flange to conceal screws
- Type 304 Stainless Steel - Matte Black Powder Coated
- Surface Mounted
- 18 gauge tubing with 1-1/2" Outside Diameter [Ø38]
- 24" [610] Length

OPERATION & MAINTENANCE

To provide Matte Black Powder Coated washroom accessories with the proper care and maintenance, the following instructions must be followed: All accessible surfaces should be cleaned with a mild liquid soap only. The surfaces should then be wiped and dried. In areas containing showers the accessories in these rooms must receive ventilation from the outside so that excess humidity can escape. Under no circumstance should the following agents be used: Abrasive powders or scouring pads, water closet cleaners, ceramic tile cleaners, solutions containing more than 1% by volume of ammonia, solutions containing acids or lye, solutions containing enzymes.

TECHNICAL INFORMATION / PRODUCT PROPERTIES

Property	Value
Dimensions	18 gauge tubing with 1-1/2" Outside Diameter [Ø38] / 24" [609] Length
Construction	Type 304 Stainless Steel - Matte Black Powder Coated 18 gauge tubing with 1-1/2" Outside Diameter [Ø38]
Mounting	Surface Mounted
Capacity	ASI grab bars are designed to meet and exceed 2010 ADA Accessibility Standards and ANSI A117.1 that fabricated product shall be of adequate strength to support a load in excess of 250 pounds (113.4 kg). Mounting to the wall is a critical part of the system to meet this requirement. The fastener system must be adequately sized to withstand the shear, tension or pullout, and torsion loads generated by the maximum loading.

INSTALLATION

Use grab bar as template to mark mounting holes locations and pre-drill holes. Install bar using two (2) #10 self-threading flat head or oval head screws (by others) or other fastener system (by others) to suit conditions for each flange. Appropriate anchoring and backing must be provided in accordance with local building codes or as specified on Architects Plans prior to wall finishing. For compliance with 2010 ADA Accessibility Standards install unit so that the top of the grab bar is 33" [840] minimum Above Finished Floor (AFF) to 36" [915] maximum AFF. Anchors are available from ASI and must be specified separately for each grab bar style scheduled (see 3900 series).

Grab Bar Configurations <https://americanspecialties.com/wp-content/uploads/grabbarconfig.pdf>

WARRANTY

One (1) Year from date of Invoice