



AMERICAN SPECIALTIES, INC.
 441 Saw Mill River Road, Yonkers, NY 10701
 (914) 476.9000 • (914) 476.0688
 www.americanspecialties.com

MODEL №: 72-ACA

ISSUED: 05/11

REVISED: 22 JUL 2020

UNIVERSAL AC ADAPTER FOR AUTOMATIC ROLL PAPER TOWEL DISPENSERS AND AUTOMATIC SOAP DISPENSERS

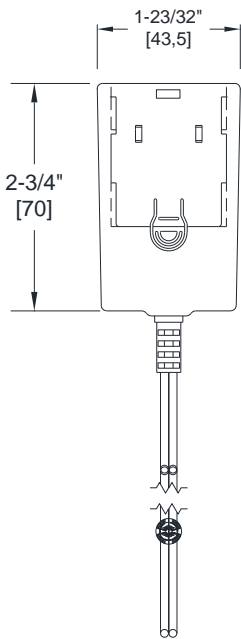

FRONT VIEW

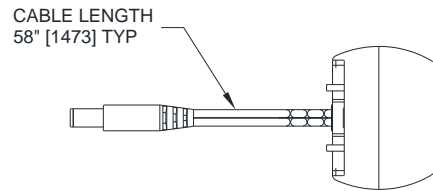

TOP VIEW

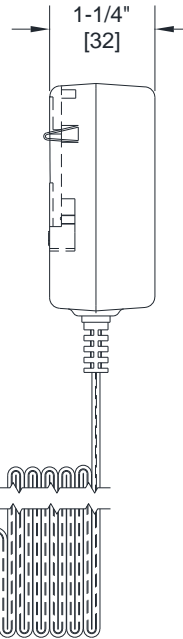

SIDE VIEW

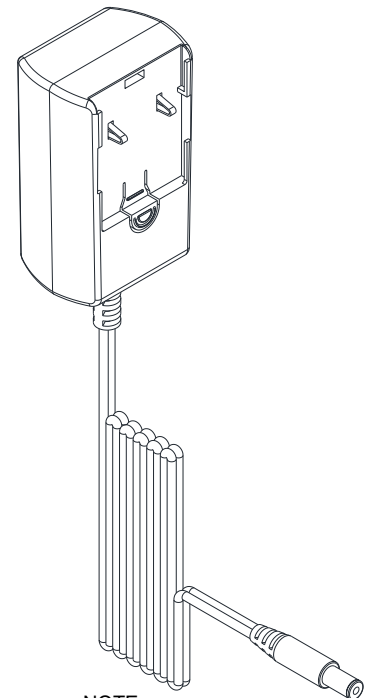
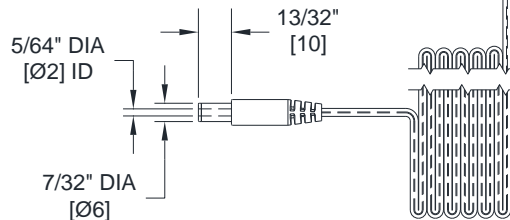

NOTE

ALL DIM'S INCH [MM]

ILLUSTRATION FOR REF ONLY AND NTS

MODEL: XA018BM0600200
 P/N: GS2C-018-0602000
 INPUT: 100-240V~, 50/60Hz, 0.45A
 OUTPUT: 6V=2.0A

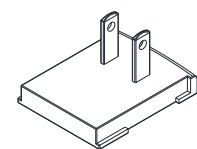

PLUG TYPE A
 (USA, CANADA, MEXICO & JAPAN)*

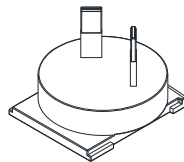

PLUG TYPE I
 (AUSTRALIA, NEW ZEALAND, CHINA & ARGENTINA)*

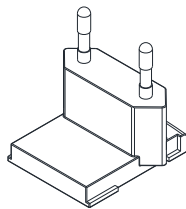

PLUG TYPE C
 (EUROPE, SOUTH AMERICA & ASIA)*

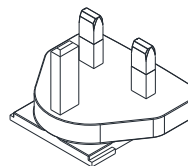

PLUG TYPE G
 (UK, IRELAND, MALTA, MALAYSIA, SINGAPORE, UNITED ARAB EMIRATES, SAUDI ARABIA, KUWAIT & BAHRAIN)*

*other countries applicable for each; call your ASI Rep for additional information, or see list on ASI website.

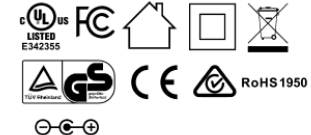

SPECIFICATION

Universal AC Adapter for Automatic Roll Paper Towel Dispensers and Automatic Soap Dispensers shall have a black plastic casing and a cable length of 59-1/16" ± 3-35/64" [1500 ± 90] with concentric Ø6 plug for Ø2 positive pin. Four (4) interchangeable plugs as one (1) USA and three (3) international styles plugs shall be supplied with unit.

Universal AC Adapter for Automatic Roll Paper Towel Dispensers and Automatic Soap Dispensers shall be Model № 72-ACA of American Specialties, Inc., 441 Saw Mill River Road, Yonkers, NY 10701-4913

INSTALLATION

Make sure that there are no batteries installed in the dispenser battery pack. Connect the adapter's output jack into the adapter socket in the dispenser. See the dispenser's technical TDS and OM & IG. Mount the required interchangeable plug type in the adapter plug base by sliding it from the top until it is latched (audible click). The Universal AC adapter with correctly attached appropriately matching blade-block shall be plugged into a 100V-240V AC circuit with a frequency of 50/60 Hz.

OPERATION

The AC Adapter remains active as long as it is plugged into an active circuit of the correct Voltage and frequency to provide the regulated output to power the selected device into which it remains securely plugged.