

**Washroom
Accessories**





FORGET EVERYTHING YOU KNOW ABOUT WASHROOM DESIGN

Welcome to the new standard for basis of design in washrooms. So what makes ASI so unique? For starters, we are the world's leading manufacturer of commercial washroom accessories. Welcome to choice, welcome to innovations, welcome to ASI.

How to use this brochure:

This brochure offers three ways to navigate our comprehensive portfolio of washroom accessories:

Navigate by collections—a family of complementary-designed products, see pages 6 & 7.

Navigate by specific product category, see pages 8 & 9.

Navigate the index by product category or model number, see pages 124-127.



WE ARE LASER FOCUSED ON DELIVERING EXACTLY WHAT YOU NEED—WHERE AND WHEN YOU NEED IT.

ASI Group's Global Reach—see how on pages 122-123.



WELCOME TO THE NEW STANDARD FOR BASIS OF DESIGN.



1 WASHROOM ACCESSORIES

The world's leading manufacturer of commercial washroom accessories. We offer the most comprehensive selection of washroom accessories available anywhere.



2 PARTITIONS

A wide range of partitions designed to enhance any interior.



Welcome to the ASI Group—the world’s leading manufacturer of partitions, washroom accessories, lockers, and visual display products.

What makes ASI Group so unique? Only ASI Group designs, engineers, and manufactures fully integrated solutions—all of our products work together seamlessly. We offer the greatest experience in the industry with the largest product breadth delivered when and where you need them.



3 LOCKERS + BENCHES

Available to be built in any configuration matrix with multiple base options, tiers, and styles to choose from.



4 VISUAL DISPLAY PRODUCTS

Through constant research, innovation, and development, we design and manufacture high quality visual display products that are easy to install and require little maintenance.

OUR COLLECTIONS

SIX DISTINCT COLLECTIONS CURATED TO WORK IN ANY WASHROOM DESIGN



Piatto™ Collection **P10**

ASI's distinctive new collection of washroom accessories is designed to stand apart by not standing out—making it integral with your washroom design. Each washroom accessory is designed to be completely recessed with concealed hinges and hardware.

NEW Matte Black Collection **P14**

ASI's Matte Black Collection provides a chic alternative for modern washrooms. Carefully curated to be versatile and powder coated for added durability, these accessories are ready to make a statement in any setting. The boldness of black creates an air of sophistication, while the subtlety of the matte finish exudes warmth.



Velare™ Collection **P20**

An elegant space-saving solution, designed to tuck away clutter, this wall mounted stainless steel cabinet conceals an automatic soap dispenser, and your choice of a paper towel dispenser or high-speed hand dryer.

While ASI offers hundreds of individual accessories, we have simplified the specifying process with our six distinct collections to serve your project's individual needs. And each of our six collections was designed as a suite of products that complement one another. Welcome to aesthetics and function in perfect harmony. Welcome to the new standard for basis of design in washrooms.

Roval™ Collection **P24**

This elegant, durable, exceptionally functional collection features subtle curves, one-piece seamless doors, and flush tumbler locks, along with fully removable waste cans, strong hinges, and integral locking system.



Simplicity™ Collection **P32**

This elegant collection combines seamless construction and crisp design lines to provide strength and comfort, beauty and durability, form and function. 18 gauge doors and 20 gauge cabinets conceal heavy-duty piano hinges.



Traditional™ Collection **P40**

This high-value collection features 22 gauge double-pan doors incorporating a "no-flex" structural fiberboard core. 22 gauge cabinets, heavy-duty piano hinges, and keyed-alike tumbler locks complete this broad product line.





**BALLROOM?
NO, IT'S YOUR
LOCKER ROOM.**

ASI just gave the locker room a makeover—you can too. Visit asi-storage.com/bod to explore the new standard for basis of design in locker rooms. **Featured above are ASI phenolic Z-lockers, ASI Alpaco™ phenolic partitions, Piatto™ completely recessed phenolic accessories, and our exclusive Velare™ concealing mirror cabinet.**

THE LARGEST PRODUCT BREADTH WITH OVER 3,000 WASHROOM ACCESSORIES

Why mix and match disparate washroom accessory products from different manufacturers, when our company has designed, engineered, and manufactured everything you need from one source? Welcome to integrated solutions. Welcome to ASI.



P. 50

Hand Dryers



P. 56

Soap Dispensers



P. 64

Sanitizing (NO) Touch Accessories



P. 67

Mirrors



P. 72

Feminine Hygiene Vendors and Disposals

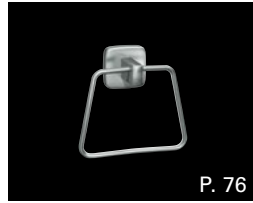

P. 76

Specialty Accessories

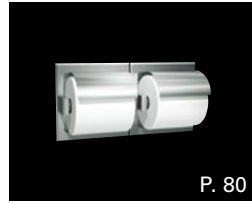

P. 80

Toilet Paper Dispensers

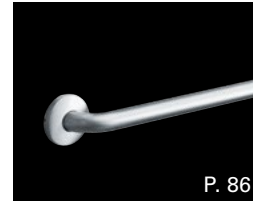

P. 86

Grab Bars



P. 88

Shower/Tub Accessories



P. 92

Baby Changing Stations

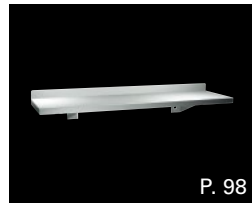

P. 98

Shelves

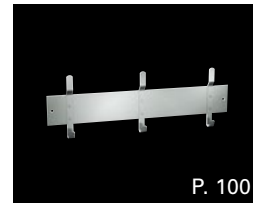

P. 100

Custodial Accessories

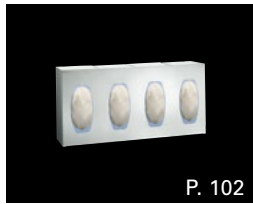

P. 102

Healthcare Accessories

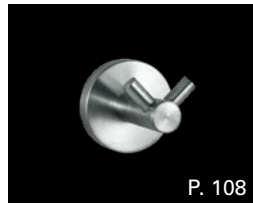

P. 108

Hospitality Accessories

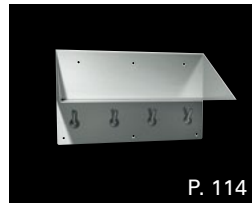

P. 114

Security Accessories

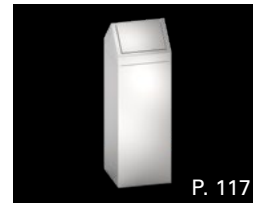

P. 117

Waste Receptacles



Our Paper Towel Dispensers and Combination Units can be found within our collections on pages 10–49.

SHOWN: 6462-41 PAPER TOWEL
DISPENSER AND WASTE RECEPTACLE



PIATTO™ COLLECTION

ASI's distinctive new collection of washroom accessories is designed to stand apart by not standing out—making it integral with your washroom design. Each washroom accessory is designed to be completely recessed, lying perfectly in the plane of the washroom wall

without any protrusion. The high-end door hinges, used to achieve this precise coplanar fit, are easily adjusted in the field. ½" (13 mm) Phenolic doors in matte black or white, close silently and effortlessly, and add an air of sophistication.

WHAT MAKES THE PIATTO™ COLLECTION UNIQUE?

COMPLETELY RECESSED

UNIQUE DESIGN

The Piatto™ collection is designed to be coplanar to the wall—an ASI exclusive.

PHENOLIC DOORS

ELEVATED STYLE—A NEW CHOICE

Phenolic doors in matte black or white were created to accentuate your washroom design.

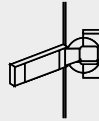

INNOVATIVE HINGES

3-way, adjustable hinges allow flexibility in the field and are concealed along with all other hardware.

VIRTUALLY GAPLESS FIT

STANDS APART BY BLENDING IN

A combination of technology and design ensures a perfect fit adding to your design by not detracting from it.



THREE-WAY ADJUSTABLE HINGE

An innovative hinge technology allows cabinet and doors to be completely recessed, with no protrusions from the plane of the wall surface. Doors can be adjusted in the field.

- Phenolic Doors
- Completely Recessed Mounting
- Concealed Internal Spring-Loaded Latch
- No Visible Hardware



6474

PIATTO™ WASTE RECEPTACLE

This unit comes with a phenolic door and concealed hardware, and is designed to be *completely* recessed into the plane of the washroom wall. Stainless steel receptacle holds 12 gal. (46 L) of washroom waste materials. For matte black phenolic door use suffix -41, for white use -00.

Unit Size:
17¼" x 40" x 6⅞"
(438 x 1016 x 166 mm)

Finished Wall Opening*:
17⅝" x 40⅛" x 6⅞"
(440 x 1018 x 170 mm)



64672-1

PIATTO™ COMPLETELY RECESSED 3-IN-1 PAPER TOWEL DISPENSER, HIGH-SPEED HAND DRYER, AND WASTE RECEPTACLE

This unit comes with a phenolic door and concealed hardware, and is designed to be *completely* recessed into the plane of the washroom wall. Features a <15 second automatic hand dryer, dispenses 400 standard C-fold or 500 standard multi-fold paper towels with a waste capacity of 6.8 gal. (26 L). Dryer has 5-year warranty. 110-120 V. Available in 208-240 V (-2). For matte black phenolic door use suffix -41, for white use -00.

Unit Size:
15⅝" x 55⅝" x 7⅞"
(391 x 1407 x 191 mm)

Finished Wall Opening*:
15⅞" x 55⅞" x 7⅞"
(392 x 1408 x 194 mm)

Decibel Level: 68.9-74.3 dB-A @ 2M



6457

PIATTO™ PAPER TOWEL DISPENSER

This unit comes with a phenolic door and concealed hardware, and is designed to be *completely* recessed into the plane of the washroom wall. Well-suited for smaller washroom with less space and traffic. Dispenses 350 C-fold or 475 multi-fold paper towels. For matte black phenolic door use suffix -41, for white use -00.

Unit Size:
12¾" x 17¼" x 4⅞"
(324 x 438 x 116 mm)

Finished Wall Opening*:
12⅞" x 17⅝" x 4¾"
(325 x 440 x 121 mm)



64696A/AC

PIATTO™ AUTOMATIC ROLL PAPER TOWEL DISPENSER AND WASTE RECEPTACLE

This unit comes with a phenolic door and concealed hardware, and is designed to be *completely* recessed into the plane of the washroom wall. No-touch unit dispenses a pre-set length per cycle from 8" (203 mm) wide, 800 ft. (244 m) long rolls. Includes 9.9 gal. (37.3 L) stainless steel waste receptacle. Battery powered. Available in AC Powered (AC). For matte black phenolic door use suffix -41, for white use -00.

Unit Size:
16⅞" x 41¼" x 9⅞"
(408 x 1048 x 246 mm)

Finished Wall Opening*:
16⅞" x 41⅝" x 10"
(410 x 1049 x 254 mm)

ALL STAINLESS STEEL IS TYPE 304 WITH SATIN FINISH, UNLESS OTHERWISE NOTED.

*All Piatto™ models require finished wall openings for installation. The edges of the finished wall opening are meant to be visible after installation, hence edges must be flat, square, straight, and plumb—no rough or unsightly edges.



6462
**PIATTO™ PAPER TOWEL DISPENSER
 AND WASTE RECEPTACLE**

This unit comes with a phenolic door and concealed hardware, and is designed to be *completely* recessed into the plane of the washroom wall. Dispenses 600 C-fold, 800 multi-fold, or 1,100 single-fold towels. 9 gal. (34 L) stainless steel waste receptacle. Towel dispensing slot has hemmed-in rolled edge for snag-free dispensing and user safety. For matte black phenolic door use suffix -41, for white use -00.

Unit Size: 17¼" x 54" x 6⅞"
 (438 x 1372 x 166 mm)

Finished Wall Opening*: 17⅞" x 54⅛" x 6⅞"
 (440 x 1373 x 170 mm)



6467
**PIATTO™ PAPER TOWEL DISPENSER
 AND WASTE RECEPTACLE**

This unit comes with a phenolic door and concealed hardware, and is designed to be *completely* recessed into the plane of the washroom wall. Dispenses 600 C-fold or 800 multi-fold paper towels. Towel dispensing slot has hemmed-in rolled edge for snag-free dispensing and user safety. Includes 4.24 gal. (16 L) stainless steel waste receptacle. For matte black phenolic door use suffix -41, for white use -00.

Unit Size: 13" x 55" x 4⅞"
 (330 x 1397 x 116 mm)

Finished Wall Opening*: 13⅞" x 55⅞" x 4⅞"
 (332 x 1399 x 119 mm)



64623
**PIATTO™ PAPER TOWEL DISPENSER
 AND WASTE RECEPTACLE**

This unit comes with a phenolic door and concealed hardware, and is designed to be *completely* recessed into the plane of the washroom wall. Well-suited for the smaller washroom with less space and traffic. Dispenses 350 C-fold or 475 multi-fold paper towels. Includes 2.2 gal. (8.4 L) stainless steel waste receptacle. For matte black phenolic door use suffix -41, for white use -00.

Unit Size: 14¼" x 28" x 4⅞"
 (362 x 711 x 116 mm)

Finished Wall Opening*: 14⅞" x 28⅞" x 4⅞"
 (364 x 713 x 119 mm)



645210A/AC
PIATTO™ AUTOMATIC ROLL PAPER TOWEL DISPENSER

This unit comes with a phenolic door and concealed hardware, and is designed to be *completely* recessed into the plane of the washroom wall. Proximity sensing no-touch unit dispenses an owner-adjustable length per cycle from 8" (203 mm) wide, 800 ft. (244 m) long rolls. Battery powered. Available in AC Powered (AC). For matte black phenolic door use suffix -41, for white use -00.

Unit Size: 16⅞" x 28" x 9⅞"
 (408 x 711 x 248 mm)

Finished Wall Opening*: 16⅞" x 28⅞" x 10"
 (410 x 713 x 254 mm)

Note: ASI Piatto™ products are made to order and are not returnable.

SHOWN: 0042-41 JUMBO ROLL TOILET TISSUE DISPENSER,
0210-41 SURFACE MOUNTED PAPER TOWEL DISPENSER, AND
9343-41 LIQUID SOAP DISPENSER



NEW

MATTE BLACK COLLECTION

ASI's Matte Black Collection provides a chic alternative for modern washrooms. Carefully curated to be versatile and powder coated for added durability, these accessories are ready to make a statement in any setting. The boldness of black creates an air of sophistication, while the subtlety of the matte finish exudes warmth.

Born out of the desire for something new and contemporary without sacrificing reliability that comes from the proven, this collection is easily paired with a wide variety of washroom accessories and toilet partitions, ranging from phenolic and plastic laminate to powder coated or stainless steel.



64672-41PC
SIMPLICITY™ IN MATTE BLACK
RECESSED 3-IN-1 CABINET—PAPER
TOWEL DISPENSER, WASTE
RECEPTACLE, AND HIGH-SPEED
HAND DRYER*

Cabinet dispenses 500 standard multi-fold or 400 standard C-fold paper towels and has a waste capacity of 6.8 gal. (26 L). 18 gauge stainless steel door, with matte black powder coated finish.

*Hand Dryer sold separately.

Unit Size:
 15³/₈" x 55³/₈" x 7¹/₂"
 (391 x 1407 x 191 mm)

Wall Opening:
 14³/₃₂" x 54³/₈" x 7¹/₄"
 (358 x 1381 x 184 mm)



6467-41PC
SIMPLICITY™ IN MATTE BLACK
RECESSED PAPER TOWEL
DISPENSER & WASTE RECEPTACLE

This recessed matte black powder coated stainless steel unit dispenses 600 C-fold or 800 multi-fold paper towels and has a 4.2 gal. (16 L) waste receptacle. 18 gauge door held closed with two (2) tumbler locks. Waste receptacle has a rolled edge finger hole for easy servicing.

Unit Size: 13" x 55" x 4³/₄"
 (330 x 1397 x 121 mm) **Wall Opening:** 11¹/₂" x 53¹/₂" x 4"
 (292 x 1359 x 102 mm)

MODEL OPTION:
6467-9-41PC Surface mounted with a matte black powder coated stainless steel collar.



6474-41PC
SIMPLICITY™ IN MATTE BLACK
RECESSED WASTE RECEPTACLE

Matte black powder coated stainless steel waste receptacle holds 12 gal. (45.4 L) of washroom waste materials. 18 gauge door is held closed with two (2) tumbler locks to prevent unauthorized access or removal.

Unit Size:
 17¹/₄" x 40" x 6³/₄"
 (438 x 1016 x 171 mm)

Wall Opening:
 15³/₄" x 38¹/₂" x 6¹/₄"
 (400 x 978 x 159 mm)

MODEL OPTION:
6474-2-41PC Semi-recessed with a matte black powder coated stainless steel collar.



64623-41PC
SIMPLICITY™ IN MATTE BLACK
RECESSED PAPER TOWEL
DISPENSER AND WASTE
RECEPTACLE

Dispenses 350 C-fold or 475 multi-fold paper towels. Includes 2.2 gal. (8.4 L) stainless steel waste receptacle. 18 gauge door is held closed with tumbler lock.

Unit Size: 14¹/₄" x 28" x 4³/₄"
 (362 x 711 x 121 mm) **Wall Opening:** 12³/₄" x 26¹/₂" x 4¹/₄"
 (324 x 673 x 108 mm)

MODEL OPTION:
64623-9-41PC Surface mounted with a matte black powder coated stainless steel collar.



0210-41
MATTE BLACK SURFACE
MOUNTED PAPER TOWEL
DISPENSER

Fabricated of 22 gauge stainless steel with matte black powder coated finish, this unit dispenses 400 C-fold or 525 multi-fold paper towels without adjustment or adapters and is fitted with a tumbler lock and heavy-duty stainless steel piano hinge.

Overall Dimensions:
 11¹/₈" x 14⁵/₈" x 4"
 (282 x 371 x 101 mm)



0477-SM-41
MATTE BLACK SURFACE
MOUNTED TOILET SEAT COVER
DISPENSER

This surface mounted unit dispenses 250 single or half-fold seat covers and is fabricated of 22 gauge stainless steel with a matte black powder coated finish.

Unit Size:
 15³/₄" x 11" x 1¹/₈"
 (400 x 279 x 48 mm)



0362-41
AUTOMATIC LIQUID SOAP AND
GEL HAND SANITIZER DISPENSER

Stainless steel soap and gel hand sanitizer dispenser in matte black finish has a capacity of 27 oz. (.8 L) and includes a tamper-resistant sight gauge.

Overall Dimensions:
 $4\frac{13}{16}'' \times 10\frac{5}{8}'' \times 4\frac{1}{8}''$
 (122 x 270 x 105 mm)



0347-41
VERTICAL SOAP DISPENSER
0345-41
HORIZONTAL SOAP DISPENSER

40 fl. oz. (1.2 L) capacity liquid soap dispenser in stainless steel with matte black powder coated finish comes with an all-purpose valve and a tamper-resistant sight gauge.

0347 Unit Size:
 $4\frac{13}{16}'' \times 8\frac{3}{16}'' \times 3\frac{15}{16}''$
 (122 x 208 x 100 mm)

0345 Unit Size:
 $8\frac{3}{16}'' \times 4\frac{13}{16}'' \times 3\frac{15}{16}''$
 (208 x 122 x 100 mm)

Spout projection: $\frac{15}{16}''$ (24 mm)



9343-41
LIQUID SOAP DISPENSER

Matte black powder coated stainless steel liquid soap dispenser has a capacity of 48 fl. oz. (1.4 L). Includes a tamper-resistant sight gauge with concealed fastening and vandal-resistant hinged filler-top.

Overall Dimensions:
 $7\frac{1}{4}'' \times 6\frac{1}{2}'' \times 3\frac{1}{16}''$
 (184 x 165 x 94 mm)

Spout Projection: $\frac{15}{16}''$ (24 mm)



0042-41
JUMBO ROLL TOILET TISSUE
DISPENSER

Holds one roll up to 10" (254 mm) diameter of $1\frac{5}{8}''$ or $2\frac{1}{4}''$ (41 or 57 mm) diameter core. Constructed of stainless steel with a matte black powder coated finish. Unit has viewing slot and tumbler lock.

Overall Dimensions:
 $10\frac{5}{8}'' \times 10\frac{5}{8}'' \times 4\frac{1}{2}''$
 (270 x 270 x 114 mm)



7305-41
SINGLE TOILET TISSUE HOLDER
7305-2-41
DOUBLE TOILET TISSUE HOLDER

Fabricated of stainless steel with matte black powder coated finish. Includes chrome plated rollers and holds one (or two for -2 model) 1800 sheet standard core roll. Heavy gauge concealed bracket mounts on wall.

7304-41
Dimensions:
 $7\frac{3}{4}'' \times 2'' \times 3\frac{3}{8}''$
 (207 x 51 x 98 mm)

7305-2-41
Dimensions:
 $13\frac{1}{2}'' \times 2'' \times 3\frac{3}{8}''$
 (343 x 51 x 98 mm)



0600-41
INTER-LOK ANGLE FRAME
MIRROR

$\frac{3}{4}'' \times \frac{5}{8}''$ (19 x 16 mm) roll formed 18 gauge stainless steel angle frame has corners heliarc welded, ground and polished smooth. Mirror is installed on a concealed hanging bracket that locks onto top and bottom of frame by tamper-proof set screws.

MODEL OPTIONS:
0600-1836-41 – 18" wide x 36" high
 (457 x 914 mm)

0600-2436-41 – 24" wide x 36" high
 (610 x 914 mm)



**0196-41
TURBO-PRO™ HIGH-SPEED ADA
HAND DRYER**

Elegant ADA-compliant, high-speed, automatic hand dryer. A HEPA filter is used to purify the air before it dries hands. The dryer provides operating flexibility—the owner controls air temperature as well as air speed. Fast drying, <15 seconds. Available in 110-120 V (-1) and 208-240 V (-2).

Overall Dimensions:
8³/₈" x 13³/₁₆" x 4"
(219 x 345 x 102 mm)

Decibel Level: 68-73.8 dB-A @ 2M



**0397-1AC-41
EZ FILL™ WATER FAUCET**

**0394-1AC-41
EZ FILL™ FOAM SOAP DISPENSER**

EZ Fill™ Top Fill Multi-Feed Soap Dispensing System allows for refill of up to 6 liquid or foam soap dispensers with one pour. The 6L (203 oz.) tank is ideal for high-traffic environments.

Complete the look with the matching EZ Fill™ Water Faucet.

See all EZ Fill™ model options on page 61.



**3801-41
STRAIGHT GRAB BAR**

Features include cover that snaps over mounting flange dimples to conceal screws and concealed mounting flange of 3¹/₈" (79 mm) O.D. diameter with 2 screw holes and 3 locking dimples; 1¹/₈" (3 mm) thick, type 304 stainless steel.

MODEL OPTIONS:

- 3801-18-41** – 18" (457 mm)
- 3801-24-41** – 24" (610 mm)
- 3801-36-41** – 36" (914 mm)
- 3801-42-41** – 42" (1067 mm)



**7385-41
TOWEL RING**

For bath and hand towels. Support post is 1/2" x 1" (13 mm x 25 mm) rectangular tubing with formed mounting flange and bracket welded on end. Ring formed from 1/4" diameter (Ø6.4 mm) stainless steel rod with matte black powder coated finish.

Unit Size:
4 1/2" x 5" x 2 1/2"
(114 x 127 x 64 mm)



**7355-24-41
TOWEL BAR – 24"**

3/4" (19 mm) diameter towel bar and mounting bracket are fabricated of stainless steel with a matte black powder coated finish. Extends 3 1/4" (83 mm) from wall.

Unit Size:
24" x 2" x 3 1/4"
(106 x 51 x 83 mm)



**7340-41
SINGLE ROBE HOOK**

Hook extends 2" (51 mm) from wall and is suitable for a robe or clothing and small carry bags. Fabricated from stainless steel with a matte black powder coated finish.

Unit Size:
2" x 2" x 2"
(51 x 51 x 51 mm)



9014-41
BABY CHANGING STATION, HORIZONTAL –
MATTE BLACK, SURFACE MOUNTED

This horizontal unit has a pull handle and concealed damped gas spring, assisting in easy operation. Fabricated of FDA-approved fungus- and bacteria-resistant plastic. Intended use for infants up to 3.5 years old and up to 50 lbs (23kg). Its vinyl-coated, adjustable safety strap assures child protection.

Overall Dimensions:

Closed: 35 ⁵ / ₃₂ " x 24 ¹ / ₄ " x 3 ⁷ / ₈ " (893 x 616 x 98 mm)	Open: 35 ⁵ / ₃₂ " x 24 ¹ / ₄ " x 22 ¹ / ₃₂ " (893 x 616 x 560 mm)
--	---



9018-41
BABY CHANGING STATION, HORIZONTAL –
MATTE BLACK, RECESSED

This horizontal unit has a pull handle and concealed damped gas spring, assisting in easy operation. Fabricated of FDA-approved fungus- and bacteria-resistant plastic. Intended use for infants up to 3.5 years old and up to 50 lbs (23kg). Its vinyl-coated, adjustable safety strap assures child protection.

Overall Dimensions:

Closed: 35 ⁵ / ₃₂ " x 24 ¹ / ₄ " x 3 ⁷ / ₈ " (893 x 616 x 98 mm)	Open: 35 ⁵ / ₃₂ " x 24 ¹ / ₄ " x 22 ¹ / ₃₂ " (893 x 616 x 560 mm)
--	---



0852-41
SANITARY NAPKIN DISPOSAL –
MATTE BLACK, SURFACE MOUNTED

Sloping cover has full length piano hinge. Fabricated of 22 gauge stainless steel. Capacity: 1.2 gal. (4.5 L).

Overall Dimensions:

7⁷/₈" x 9¹/₁₆" x 4"
 (200 x 246 x 102 mm)



0864-41
(30) NAPKIN/ (27) TAMPON VENDOR – MATTE BLACK,
SURFACE MOUNTED – 25¢, 50¢ OR FREE OPERATION

Dispenses 30 feminine napkins and 27 tampons. Furnished with an adjustable flange for recessing in wall depths from 1" to 6" (26 to 152 mm). Universal coin mechanism allows for 25¢, 50¢, and free (no coin) operation. Choose appropriate suffix (-25, -50, or -F). Coin box has a separately keyed lock.

Overall Dimensions:

11-3/4" x 26-1/8" x 6-1/2"
 (298 x 663 x 165 mm)



**0199-1-41
ASITURBO-ADA ACCESSIBILITY COMPLIANT
HIGH-SPEED HAND DRYER**

Fast drying, <15 seconds, and automatic operation using infrared sensor with auto-resetting thermostat. Owner-adjustable air speed and temperature and on/off heating options with shut off when user removes hands from sensor zone. Standard white cover; optional bright or satin stainless steel finish. Available in 110-120 V (-1) and 208-240 V (-2).

Overall Dimensions:
10⁵/₁₆" x 8¹⁵/₃₂" x 4"
(270 x 215 x 102 mm)



**0030-41
MATTE BLACK TOILET TISSUE DISPENSER,
TWIN HIDE-A-ROLL — SURFACE MOUNTED**

Holds two rolls up to 5 1/4" (133 mm) diameter (1800 sheets). Top roll automatically drops in place when bottom roll is used up. Type 304 stainless steel cabinet and mechanism. Theft resistant spindles.

Unit Size:
6" x 12" x 6 1/2"
(152 x 305 x 165 mm)



**3800-41
MATTE BLACK POWDER COATED
SNAP FLANGE GRAB BARS**

Features include cover that snaps over mounting flange dimples to conceal screws and concealed mounting flange of 3 1/8" (79 mm) diameter with 2 screw holes and 3 locking dimples; 1/8" (3 mm) thick, type 304 stainless steel. Cover is 22 gauge type 304 stainless steel with a powder coated matte black finish and 3 3/16" (81 mm) diameter.

1-1/2" DIA (38 mm) 3800-41 Series Straight Grab Bar
With Matte Black Powder Coated Finish



**0839-41
WASTE RECEPTACLE (19 GAL.) —
MATTE BLACK, FREE STANDING**

Fabricated of 22 gauge stainless steel; holds 19 gallons (72 L) of waste. Top is removable for easy maintenance and bottom is equipped with four (4) black rubber feet.

Overall Dimensions:
12³/₈" x 32" x 12¹/₂"
(314 x 800 x 318 mm)

SHOWN: 0661-T VELARE™ BTM SYSTEM – STAINLESS STEEL
CABINET WITH FRAMELESS MIRROR, LIQUID SOAP DISPENSER,
AND PAPER TOWEL DISPENSER



VELARE™ COLLECTION

An elegant space-saving solution, designed to tuck away clutter, this wall mounted stainless steel cabinet conceals an automatic soap dispenser, and your choice of a paper towel dispenser or high-speed hand dryer (Dryer Model 0196—equipped with a HEPA filter).

The sophisticated design is ideal for iconic buildings—the dispensing capacity makes it ideal for any high-traffic environment. Another reason to specify ASI!

WHAT MAKES THE VELARE™ COLLECTION UNIQUE?

ARTFULLY CONCEALED

ARTFULLY CONCEALED

Consumables are concealed behind the mirror to accentuate the overall style.

SOAP



CONCEALED SOAP DISPENSER

High-capacity foam or liquid soap dispenser makes Velare™ ideal for high frequency use restrooms.

TOWEL



PAPER TOWEL OPTION

Velare™ provides paper towels as an option for drying hands. 500 towel capacity.

AIR



HAND DRYER OPTION

Optional high-speed, low-decibel hand dryer is equipped with a HEPA filter.

ALL-IN-ONE CABINET HOUSES AN AUTOMATIC SOAP DISPENSER, AND YOUR CHOICE OF PAPER TOWEL DISPENSER OR HAND DRYER—NOW AVAILABLE WITH MIRROR FILLERS FOR FLEXIBILITY.

Backlit icons etched into the frameless mirror direct the user to their choice of soap and drying option. The self-contained design reduces hazards associated with wet floors. The ¼" thick tempered glass mirror, supported by twin, damped gas springs, opens up to 90° for easy maintenance.





0661-1
VELARE™ STAINLESS STEEL CABINET WITH
FRAMELESS MIRROR, LIQUID SOAP DISPENSER,
AND HIGH-SPEED HAND DRYER (110-120 V)

Designed with elegance and safety in mind, this wall mounted stainless steel cabinet conceals a hands-free automatic liquid soap dispenser with a .4 gal. (1.5 L) capacity and a high-speed hand dryer (110-120 V) equipped with a HEPA filter.

MODEL OPTION:
0661-2 Velare™ Stainless Steel Cabinet with Liquid Soap and Hand Dryer (208-240 V).

Overall Dimensions:
 23³/₁₆" x 35⁷/₁₆" x 7⁹/₁₆"
 (600 x 900 x 192)



0661-T
VELARE™ STAINLESS STEEL CABINET WITH
FRAMELESS MIRROR, LIQUID SOAP DISPENSER,
AND PAPER TOWEL DISPENSER

This wall mounted stainless steel cabinet conceals a hands-free automatic liquid soap dispenser with a .4 gal. (1.5 L) capacity and paper towel dispenser with a 500 towel capacity.

Overall Dimensions:
 23³/₁₆" x 35⁷/₁₆" x 7⁹/₁₆"
 (600 x 900 x 192)



0661-FM-14
VELARE™ STAINLESS STEEL FRAMELESS
MIRROR FILLER MODULE

Wall mounted stainless steel cabinet filler module provides spacing between other Velare™ BTM modules where needed. Mirror is made from 1/4" (6 mm) thick frameless tempered glass conforming to ASTM C-1048 with pencil edges and eased corners with SS sheet intermediate stiffener and SS back plate with integral welded support mounts.

Overall Dimensions:
 14³/₄" x 35⁷/₁₆" x 7⁹/₁₆"
 (375 x 900 x 192)



0661-FM-23
VELARE™ STAINLESS STEEL FRAMELESS
MIRROR FILLER MODULE

Wall mounted stainless steel cabinet filler module provides spacing between other Velare™ BTM modules where needed. Mirror is made from 1/4" (6 mm) thick frameless tempered glass conforming to ASTM C-1048 with pencil edges and eased corners with SS sheet intermediate stiffener and SS back plate with integral welded support mounts.

Overall Dimensions:
 23¹/₄" x 35⁷/₁₆" x 7⁹/₁₆"
 (591 x 900 x 192)



0663-1
VELARE™ STAINLESS STEEL CABINET WITH
FRAMELESS MIRROR, FOAM SOAP DISPENSER,
AND HIGH-SPEED HAND DRYER (110-120 V)

This wall mounted stainless steel cabinet conceals a hands-free automatic foam soap dispenser with a .4 gal. (1.5 L) capacity and a high-speed hand dryer (110-120 V) equipped with a HEPA filter.

MODEL OPTION:
0663-2 Velare™ Stainless Steel Cabinet with Foam Soap and Hand Dryer (208-240 V).

Overall Dimensions:
 23⁵/₁₆" x 35⁷/₁₆" x 7⁹/₁₆"
 (600 x 900 x 192)



0663-T
VELARE™ STAINLESS STEEL CABINET WITH
FRAMELESS MIRROR, FOAM SOAP DISPENSER,
AND PAPER TOWEL DISPENSER

This wall mounted stainless steel cabinet conceals a hands-free automatic foam soap dispenser with a .4 gal. (1.5 L) capacity and paper towel dispenser with a 500 towel capacity.

Overall Dimensions:
 23⁵/₁₆" x 35⁷/₁₆" x 7⁹/₁₆"
 (600 x 900 x 192)

Aptly named **Velare™**, which means to veil, this elegant, space-saving mirror cabinet lives up to its name by concealing a soap dispenser (liquid or foam) and your choice of a high-speed hand dryer or paper towel dispenser.

Velare™ minimizes the hazards of water spilling on the floor by housing soap and drying components directly above the sink. The mirror, made of 1/4" thick tempered glass with pencil edges, is supported by twin damped gas springs, which allow the cabinet to be opened up to 90° for easy maintenance.

Backlit icons etched into the mirror intuitively indicate soap and drying options, making this cabinet both elegant and easy to use. This marriage of elegance, safety, and functionality makes Velare™ ideal for a wide range of building types, from sophisticated corporate headquarters to high-traffic washrooms in entertainment centers and airports.



SHOWN: 20469 RECESSED
PAPER TOWEL DISPENSER
AND WASTE RECEPTACLE



ROVAL™ COLLECTION

Engineered for high-profile settings, this collection adds elegance, durability, and exceptional functionality to any washroom without becoming the focal point.

This collection is ideal for the most aesthetically demanding applications. All features are functionally superior, quickly installed, and easily maintained.

WHAT MAKES THE ROVAL™ COLLECTION UNIQUE?

18-22
GAUGE

STAINLESS STEEL CONSTRUCTION

Our collection is constructed of stainless steel, which is tough, durable, stain-resistant, and easy to clean.



INTEGRAL LOCKING SYSTEM

Our durable, integral locking system prevents tampering and theft.

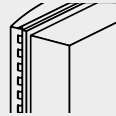

STAKED PIANO HINGES

Our heavy-duty, staked piano hinges provide security and a neat appearance, and they stand up to heavy use.



REMOVABLE WASTE RECEPTACLE

Fully removable waste cans allow contents to be easily discarded for efficient ongoing maintenance and cleanliness.



MANUAL AND AUTOMATIC PAPER TOWEL/ TOILET TISSUE DISPENSERS



MIRRORS



AUTOMATIC HAND DRYERS



204623
**ROVAL™ RECESSED PAPER TOWEL DISPENSER AND
 REMOVABLE WASTE RECEPTACLE**

Dispenses 350 C-fold, 475 multi-fold paper towels. 3.0 gal. (11.2 L) removable stainless steel waste receptacle with a tumbler lock. 22 gauge stainless steel door in a satin finish with a flush lock and a heavy-duty $\frac{3}{16}$ " staked piano hinge on door.

MODEL OPTION:
204623-9 Surface mounted with a stainless steel collar.

Unit Size:
 12 $\frac{3}{4}$ " x 28" x 6 $\frac{1}{2}$ "
 (325 x 710 x 165 mm)

Wall Opening:
 11 $\frac{1}{4}$ " x 26 $\frac{7}{16}$ " x 3 $\frac{15}{16}$ "
 (286 x 672 x 100 mm)



20469
**ROVAL™ RECESSED PAPER TOWEL DISPENSER
 AND WASTE RECEPTACLE**

Dispenses 600 C-fold or 800 multi-fold paper towels. 14.8 gal. (56 L) removable waste receptacle. Door made of 18 gauge stainless steel with a heavy-duty $\frac{3}{16}$ " staked piano hinge.

MODEL OPTION:
20469-9 Surface mounted with a stainless steel collar.

Unit Size:
 17 $\frac{3}{8}$ " x 56 $\frac{1}{16}$ " x 9"
 (441 x 1424 x 228 mm)

Wall Opening:
 15 $\frac{3}{8}$ " x 54 $\frac{3}{8}$ " x 4"
 (397 x 1381 x 102 mm)



204692A
ROVAL™ AUTOMATIC RECESSED ROLL PAPER TOWEL DISPENSER AND WASTE RECEPTACLE

Fabricated of 18 gauge stainless steel. 17.8 gal. (67.2 L) removable waste receptacle. Towel length is determined by owner by setting length, delay, and paper saver switches.

SUFFIX OPTIONS FOR POWER/MOUNTING:
[A, A-6, A-9, AC, AC-6, AC-9]

- A:** Powered by 4 D-size batteries (not included).
- AC:** Powered by AC plug-in adapter.
- 6:** Semi-recessed with a stainless steel collar.
- 9:** Surface mounted with a stainless steel collar.

Unit Size: 17 ³ / ₈ " x 56 ¹ / ₁₆ " x 11 ¹ / ₁₆ " (441 x 1424 x 297 mm)	Wall Opening: 15 ¹³ / ₁₆ " x 54 ¹ / ₁₆ " x 10" (402 x 1389 x 254 mm)
--	---



2046921A
ROVAL™ AUTOMATIC RECESSED ROLL PAPER TOWEL DISPENSER AND WASTE RECEPTACLE FOR ADA COMPLIANCE

Smaller waste receptacle, 13.5 gal. (51.1 L), allows unit to be ADA compliant. Cabinet and frame fabricated of 22 gauge stainless steel. Internal shelf is ideal for paper towel storage. Towel length is determined by owner by setting length, delay, and paper saver switches.

SUFFIX OPTIONS FOR POWER/MOUNTING:
[A, A-6, A-9, AC, AC-6, AC-9]

- A:** Powered by 4 D-size batteries (not included).
- AC:** Powered by AC plug-in adapter.
- 6:** Semi-recessed with a stainless steel collar.
- 9:** Surface mounted with a stainless steel collar.

Unit Size: 17 ³ / ₈ " x 56 ¹ / ₁₆ " x 11 ¹ / ₁₆ " (441 x 1424 x 296 mm)	Wall Opening: 15 ¹³ / ₁₆ " x 54 ¹ / ₁₆ " x 10" (402 x 1389 x 254 mm)
--	---



20826
ROVAL™ SURFACE MOUNTED WASTE RECEPTACLE

Receptacle front and sides fabricated of 20 gauge stainless steel with satin finish. 12.8 gal. (48.4 L) waste capacity.

MODEL OPTION:

20826-T Closed top, spring-loaded door.
 Capacity 12.8 gal. (48.4 L).

Overall Dimensions:

15¹/₈" x 23" x 8¹/₂"
 (384 x 584 x 216 mm)



20458
ROVAL™ SEMI-RECESSED REMOVABLE WASTE RECEPTACLE

Easy maintenance—removable 20 gauge stainless steel waste receptacle locks into cabinet with a tumbler lock for security. Capacity 11.2 gal. (42.6 L). Frame and cabinet fabricated of 22 gauge stainless steel with satin finish.

Unit Size:

17³/₈" x 27³/₄" x 8¹⁵/₁₆"
 (441 x 705 x 227 mm)

Wall Opening:

15³/₄" x 26" x 3¹⁵/₁₆"
 (400 x 660 x 100 mm)



20852
ROVAL™ SURFACE MOUNTED SANITARY WASTE RECEPTACLE

Lid is drawn one-piece construction and is secured to the cabinet with a heavy-duty ⁹/₁₆" multi-staked concealed piano hinge. Cabinet top and body fabricated of 22 gauge stainless steel. 1 gal. (3.7 L) waste capacity.

Overall Dimensions:

7¹/₄" x 10" x 3¹/₂"
 (185 x 253 x 89 mm)



20470
ROVAL™ RECESSED SANITARY NAPKIN DISPOSAL

Heavy-duty ⁹/₁₆" staked piano hinge adds to the robust construction. Drawn one-piece seamless door of 22 gauge stainless steel with a satin finish. 1.0 gal. (3.7 L) waste capacity.

Unit Size:

12¹³/₁₆" x 11" x 5¹/₁₆"
 (325 x 280 x 138 mm)

Wall Opening:

15³/₄" x 26" x 3¹⁵/₁₆"
 (400 x 660 x 100 mm)



204684
ROVAL™ RECESSED DUAL SANITARY NAPKIN AND TAMPON VENDOR

Dispenses 31 napkins and 22 tampons. Door has 18 gauge satin finish stainless steel, with 2 flush tumbler locks. Universal coin mechanism allows for 25¢, 50¢, and free (no coin) operation. Choose appropriate suffix (-25, -50 or -F).

MODEL OPTION:

204684-9 Surface mounted with a stainless steel collar.

Unit Size:

17⁵/₁₆" x 27³/₄" x 5⁵/₈" (440 x 705 x 143 mm)

Wall Opening:

15³/₄" x 26¹/₈" x 4" (397 x 664 x 102 mm)



20452
ROVAL™ RECESSED PAPER TOWEL DISPENSER

Dispenses 600 C-fold or 800 multi-fold paper towels. Door fabricated of 18 gauge drawn one-piece stainless steel with satin finish. Door secured with 3/16" staked piano hinge and flush tumbler lock.

Overall Dimensions:
12 3/4" x 28" x 5 1/16"
(324 x 711 x 137 mm)



204523A
ROVAL™ AUTOMATIC RECESSED ROLL PAPER TOWEL DISPENSER

Fabricated of 22 gauge stainless steel with satin finish. Towel length is determined by owner by setting length, delay, and paper saver switches.

SUFFIX OPTIONS FOR POWER/MOUNTING:
[A, A-6, A-9, AC, AC-6, AC-9]

A: Powered by 4 D-size batteries (not included).

AC: Powered by AC plug-in adapter.

-6: Semi-recessed with a stainless steel collar.

-9: Surface mounted with a stainless steel collar.

Unit Size:
17 7/8" x 27 3/4" x 11 11/16"
(441 x 705 x 297 mm)

Wall Opening:
15 3/4" x 26" x 10"
(400 x 660 x 254 mm)



20210
ROVAL™ SURFACE MOUNTED PAPER TOWEL DISPENSER

Dispenses 400 C-fold or 525 multi-fold paper towels. Fabricated of 22 gauge stainless steel with satin finish. Fitted with tumbler lock and heavy-duty stainless steel staked piano hinge.

Overall Dimensions:
11 1/16" x 13 3/16" x 4 7/16"
(281 x 345 x 124 mm)



20030
ROVAL™ SURFACE MOUNTED TWIN HIDE-A-ROLL TOILET TISSUE DISPENSER

Holds 2 rolls up to 5.25" (133 mm) diameter (double roll capacity 3600 sheets); top roll automatically drops in place when bottom roll is used up. Fabricated of 22 gauge satin finish stainless steel. Theft-resistant spindles with integral plated steel endpins.

MODEL OPTION:
20031 With flange for semi-recessed mounting.

Overall Dimensions:
6 1/16" x 12 1/8" x 6 1/2"
(154 x 308 x 165 mm)



 **20477-SM**
ROVAL™ SURFACE MOUNTED SEAT COVER DISPENSER

Dispenses 250 seat covers. Fabricated of 20 gauge stainless steel with a satin finish.

Overall Dimensions:
15 3/4" x 11" x 2 3/8"
(400 x 280 x 60 mm)



9013
RECESSED STAINLESS STEEL BABY CHANGING STATION

ADA-compliant unit features welded stainless steel for long and reliable use. Exposed surfaces are satin finish. Easy one-handed operation is assisted by a pull handle and concealed spring. The changing surface is high-impact-resistant plastic for easy cleaning. Featuring a two-part adjustable safety strap, intended use for infants up to 3.5 years old and a load capacity of up to 50 lbs (23 kg), this product ensures child protection.

MODEL OPTION:
9013-9 Surface mounted with a stainless steel collar.

Overall Dimensions:
 Open: 37" x 25½" x 17¾"
 (940 x 648 x 451 mm)
 Closed: 37" x 25½" x 3/8"
 (940 x 648 x 10 mm)

Wall Opening:
 34¼" x 22¾" x 3/4"
 (870 x 578 x 95 mm)



9343
HORIZONTAL SURFACE MOUNTED SOAP DISPENSER

All-purpose valve dispenses liquid soaps with a capacity of 48 fl. oz. (1.4 L). It has a tamper-resistant sight gauge with concealed fastening and vandal-resistant hinged filler-top.

MODEL OPTION:
NEW 9343-41 Matte Black.

Overall Dimensions:
 7¼" x 6½" x 3¼"
 (184 x 165 x 94 mm)
 Spout Projection: 1/8" (24 mm)



20365
ROVAL™ AUTOMATIC SURFACE MOUNTED FOAM SOAP AND HAND SANITIZER DISPENSER

Hands-free foam soap and hand sanitizer dispenser powered by 6 AA-size batteries (not included). Seamless drawn stainless steel cover. Translucent removable internal tank for easy-to-view level. LED indicates adjustment and operation. Capacity: 34 oz. (1 L).

Overall Dimensions:
 5½" x 10¾" x 4"
 (140 x 273 x 102 mm)



20364
ROVAL™ AUTOMATIC SURFACE MOUNTED LIQUID SOAP AND GEL HAND SANITIZER DISPENSER

Hands-free liquid soap and gel hand sanitizer dispenser powered by 6 AA-size batteries (not included). Seamless drawn stainless steel cover. Translucent removable internal tank for easy-to-view level. LED indicates adjustment and operation. Capacity: 34 oz. (1 L). d.

Overall Dimensions:
 5½" x 10¾" x 4"
 (140 x 276 x 102 mm)



20363
ROVAL™ SURFACE MOUNTED LIQUID SOAP DISPENSER

Push button operation, valve needs no more than 5 lbs. of pressure to actuate. Dispenses liquid soap Capacity: 57 oz. (1.7 L).

Overall Dimensions:
 5½" x 10¼" x 4"
 (139 x 274 x 102 mm)
 Spout Projection: 1/8" (24 mm)



20199
ROVAL™ SEMI-RECESSED HIGH-SPEED HAND DRYER

This high-performing hand dryer, with a drying time of 10-15 seconds, has a cover made of 18 gauge stainless steel and uniquely complements the Roval™ Collection with its bowed face and gently radiused edges. 5-year warranty. Optional voltages available.

Unit Size: 11" x 15½" x 5²³/₃₂"
 (279 x 394 x 145 mm)
Wall Opening: 10½" x 14⁵/₈" x 3¼"
 (267 x 371 x 83 mm)

Decibel Level: 69 dB-A @ 2M



20200
TRI-Umph™ HIGH-SPEED HAND DRYER

Satin look cover: ABS plastic with silver ions. Ergonomic—no need to bend over or bend knees. Air blows down and back from vents above. No water splash-back. Ultra hygienic—over 99% of airborne bacteria is eliminated with the removable Triple HEPA Filter System. 5-year warranty. Optional voltages available.

Overall Dimensions:
 12¹/₁₆" x 23¹/₈" x 7³/₄"
 (322 x 588 x 196 mm)

Decibel Level: 62.9-67.2 dB-A @ 2M

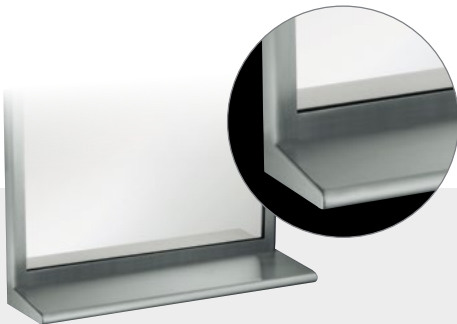

20655
ROVAL™ STAINLESS STEEL MIRROR WITH INTEGRAL SHELF

The gently radiused edges provide added strength and complement the curves of the ASI Roval™ Collection. Mirror frame and 6" wide curved edge shelf are fabricated of 18 gauge stainless steel with satin finish. Mirror frame has polished seamless mitered corners and 0.25" (6.4 mm) thick plate glass mirror. Choice of sizes.

MODEL OPTION:
20650 Mirror without shelf.



20692
ROVAL™ SURFACE MOUNTED SHELF

Fabricated of 18 gauge stainless steel, the 6" wide shelf has a ¾" (19 mm) gently radiused edge that uniquely complements the curves of the ASI Roval™ Collection. Choice of sizes.

Overall Dimensions:
 6" x 12"-72"
 (152 x 305-1829 mm)

SHOWN: 6467 PAPER TOWEL
DISPENSER AND
WASTE RECEPTACLE



SIMPLICITY™ COLLECTION

Combining seamless construction and crisp design lines, this elegant collection provides strength, comfort, beauty, and durability.

All units have keyed-alike tumbler locks for ease in maintenance. Automatic dispensers feature a proximity sensor activated dispensing mechanism.

WHAT MAKES THE SIMPLICITY™ COLLECTION UNIQUE?

18

GAUGE

STAINLESS STEEL CONSTRUCTION

Constructed with 18 gauge stainless steel doors and 20 gauge cabinets, which are attached with concealed $\frac{3}{16}$ " (5 mm) diameter piano hinges for durability.

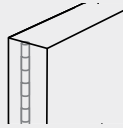

SEAMLESS ONE-PIECE COVER-ALL DOOR

The door is designed for a sleek and streamlined appearance, making it easy to maintain even with heavy use.



SAFE EASY DISPENSING

Towel dispensers have hemmed opening for safe, easy dispensing, minimizing waste and ensuring hygienic use.



EASY LIFT OUT RECEPTACLE

Fully removable stainless steel waste cans allow contents to be easily discarded for efficient ongoing maintenance and cleanliness.



PAPER TOWEL DISPENSERS



FEMININE HYGIENE VENDORS



SOAP DISPENSERS



6462
SIMPLICITY™ RECESSED
PAPER TOWEL DISPENSER AND
WASTE RECEPTACLE

Dispenses 800 multi-fold or 600 C-fold towels, standard. Provided adapter allows the flexibility to change the capacity to up to 1,100 single-fold paper towels. 9 gal. (34 L) stainless steel waste receptacle. 18 gauge stainless steel door.

MODEL OPTIONS:

- 6462-2** Semi-recessed with a stainless steel collar.
- 6462-9** Surface mounted with a stainless steel collar.

Unit Size:

17¼" x 54" x 6½"
 (438 x 1372 x 165 mm)

Wall Opening:

15¾" x 52½" x 6"
 (400 x 1335 x 152 mm)



6467
SIMPLICITY™ RECESSED
PAPER TOWEL DISPENSER AND
WASTE RECEPTACLE

Dispenses 600 C-fold or 800 multi-fold paper towels. 4.24 gal. (16 L) stainless steel waste receptacle. 18 gauge stainless steel door.

MODEL OPTIONS:

- NEW 6467-41PC** Matte Black
- 6467-9** Surface mounted with a stainless steel collar.
- NEW 6467-9-41PC** Surface mounted with a matte black stainless steel collar.

Unit Size:

13" x 55" x 4¾"
 (330 x 1397 x 121 mm)

Wall Opening:

11½" x 53½" x 4"
 (292 x 1359 x 102 mm)

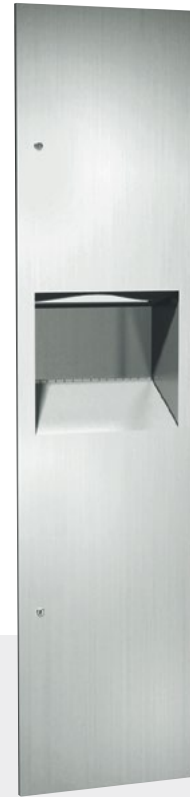

64676
SIMPLICITY™ RECESSED
PAPER TOWEL DISPENSER AND
WASTE RECEPTACLE

Dispenses 600 C-Fold, 800 multi-fold, or 1100 single-fold towels. 7 gal. (26.5 L) stainless steel waste receptacle. 18 gauge stainless steel door.

MODEL OPTIONS:

- 64676-2** Semi-recessed with a stainless steel collar.
- 64676-9** Surface mounted with a stainless steel collar.

Unit Size:

13" x 55" x 6½"
 (330 x 1397 x 165 mm)

Wall Opening:

11½" x 53½" x 6"
 (292 x 1359 x 152 mm)



NEW



646924A
SIMPLICITY™ AUTOMATIC RECESSED ROLL PAPER TOWEL DISPENSER AND WASTE RECEPTACLE

Proximity sensing no-touch recessed unit dispenses a pre-set length per cycle from 8" or 9" (205 or 230 mm) wide, 800 ft. (244 mm) long rolls. 12 gal. (45.4 L) waste receptacle. Fabricated of 22 gauge stainless steel, 18 gauge door.

SUFFIX OPTIONS FOR POWER/MOUNTING:
[A, A-9, AC, AC-9]

A: Powered by 4 D-size batteries (not included).
AC: Powered by AC plug-in adapter.
-9: Surface mounted with a stainless steel collar.

Unit Size: 17¼" x 56" x 10¼" (438 x 1422 x 260 mm)	Wall Opening: 15¾" x 54½" x 4" (400 x 1384 x 102 mm)
---	---



64672-1
SIMPLICITY™ RECESSED 3-IN-1 PAPER TOWEL DISPENSER, HIGH-SPEED HAND DRYER AND WASTE RECEPTACLE

Paper towel dispenser with waste receptacle and < 15 second automatic hand dryer. Dispenses 500 multi-fold or 400 C-fold paper towels, and has a waste capacity of 6.8 gal. (26 L). 18 gauge stainless steel door. Dryer has 5-year warranty. 110-120 V. Optional voltages available.

MODEL OPTIONS:
64672-2 Dryer Voltage is 208-240 V Dryer.
64672 Cabinet only—no hand dryer included.
NEW 64672-41PC Cabinet Only—Matte Black.

Unit Size: 15⅝" x 55⅜" x 7½" (391 x 1407 x 191 mm)	Wall Opening: 14⅜" x 54⅜" x 7¼" (358 x 1381 x 184 mm)
---	--

Decibel Level: 68.9-74.3 dB-A @ 2M





0198-MH
SAFE-DRI™ MENTAL HEALTH
APPROVED RECESSED
HIGH-SPEED HAND DRYER

Anti-ligature dryer designed for Behavioral Health environments—angled top, welded corners and single tube exhaust prevent looping, tying off, wedging, and prying. Tamper-resistant 18 gauge stainless steel cover and flush pin-hex security screws. Optional voltages available.

Unit Size:
 12⁵/₈" x 15³/₄" x 5¹/₁₆"
 (320 x 400 x 140 mm)

Wall Opening:
 11⁷/₈" x 14³/₄" x 5¹/₈"
 (303 x 376 x 130 mm)

Decibel Level:
 66 dB-A @ 2M



645224AC
SIMPLICITY™ AUTOMATIC
RECESSED ROLL PAPER TOWEL
DISPENSER

Dispenses pre-set length from 8" or 9" wide rolls. Fabricated of 22 gauge stainless steel, 18 gauge door.

**SUFFIX OPTIONS FOR POWER/
 MOUNTING: [A, A-6, AC, AC-6, AC-9]**

AC: Powered by AC plug-in adapter.
-6: Semi-recessed with a stainless steel collar.
-9: Surface mounted with a stainless steel collar.

Unit Size:
 17¹/₄" x 30¹/₂" x 10¹/₄"
 (438 x 775 x 260 mm)

Wall Opening:
 15³/₄" x 29" x 4"
 (400 x 737 x 102 mm)



64623
SIMPLICITY™ RECESSED PAPER
TOWEL DISPENSER AND WASTE
RECEPTACLE

Dispenses 350 C-fold or 475 multi-fold paper towels. 2.2 gal. (8.4 L) stainless steel waste receptacle. 18 gauge stainless steel door.

MODEL OPTIONS:
NEW 64623-41PC Matte Black.
64623-9 Surface mounted with a stainless steel collar.
NEW 64623-9-41PC Surface mounted with a matte black stainless steel collar.

Unit Size:
 14¹/₄" x 28" x 4³/₄"
 (362 x 711 x 121 mm)

Wall Opening:
 12³/₄" x 26¹/₂" x 4¹/₄"
 (324 x 673 x 108 mm)



645210A
SIMPLICITY™ AUTOMATIC RECESSED ROLL PAPER TOWEL DISPENSER

Proximity sensing no-touch recessed unit dispenses an owner-adjustable length per cycle from 8" (205 mm) wide, 800 ft. (244 m) long rolls. Fabricated of 20 gauge stainless steel with satin finish.

SUFFIX OPTIONS FOR POWER/MOUNTING:
[A, A-6, A-9, AC, AC-6, AC-9]

- A:** Powered by 4 D-size batteries (not included).
- AC:** Powered by AC plug-in adapter.
- 6:** Semi-recessed with a stainless steel collar.
- 9:** Surface mounted with a stainless steel collar.

Unit Size:
 16^{5/16}" x 28" x 9"
 (408 x 711 x 229 mm)

Wall Opening:
 15^{3/4}" x 26^{1/2}" x 10^{1/4}"
 (400 x 673 x 260 mm)



64696
SIMPLICITY™ RECESSED ROLL PAPER TOWEL DISPENSER AND WASTE RECEPTACLE

Mechanically dispenses 8" or 9" (205 or 230 mm) wide, 800 ft. (244 m) long rolls in pre-set lengths per stroke. 9.2 gal. (34.8 L) stainless steel waste receptacle. 18 gauge stainless steel door.

MODEL OPTIONS:
64696-6 Semi-recessed with a stainless steel collar.
64696-9 Surface mounted with a stainless steel collar.

Unit Size:
 16^{1/16}" x 41^{1/4}" x 9^{5/8}"
 (408 x 1048 x 245 mm)

Wall Opening:
 14^{5/8}" x 39^{3/4}" x 9^{1/4}"
 (371 x 1010 x 235 mm)



64696A
SIMPLICITY™ AUTOMATIC RECESSED ROLL PAPER TOWEL DISPENSER AND WASTE RECEPTACLE

Proximity sensing no-touch unit dispenses a pre-set length per cycle from 8" or 9" (205 or 230 mm) wide, 800 ft. (244 m) long rolls. 9.9 gal. (37.3 L) stainless steel waste receptacle. 18 gauge stainless steel door.

SUFFIX OPTIONS FOR POWER/MOUNTING:
[A, A-6, A-9, AC, AC-6, AC-9]

- A:** Powered by 4 D-size batteries (not included).
- AC:** Powered by AC plug-in adapter.
- 6:** Semi-recessed with a stainless steel collar.
- 9:** Surface mounted with a stainless steel collar.

Unit Size:
 16^{1/16}" x 41^{1/4}" x 10^{1/4}"
 (408 x 1048 x 261 mm)

Wall Opening:
 14^{5/8}" x 39^{3/4}" x 10"
 (371 x 1010 x 254 mm)



6457
SIMPLICITY™ RECESSED PAPER TOWEL DISPENSER

Well-suited for the smaller washroom with less space and traffic, this unit dispenses 350 C-fold or 475 multi-fold paper towels.

Unit Size:
 12³/₄" x 17¹/₄" x 4¹/₂"
 (324 x 438 x 114 mm)

Wall Opening:
 11¹/₄" x 15³/₄" x 4¹/₄"
 (286 x 400 x 108 mm)



6452
SIMPLICITY™ RECESSED PAPER TOWEL DISPENSER

Dispenses 600 C-fold or 800 multi-fold paper towels. 18 gauge stainless steel door.

MODEL OPTION:
6452-9 Surface mounted with a stainless steel collar.

Unit Size:
 14¹/₄" x 28" x 4¹/₂"
 (362 x 711 x 114 mm)

Wall Opening:
 12³/₄" x 26¹/₂" x 4¹/₄"
 (324 x 673 x 108 mm)



6459
SIMPLICITY™ RECESSED WASTE RECEPTACLE

Stainless steel waste receptacle holds 4 gal. (15 L) of waste and has a self-closing panel that covers its opening. 18 gauge stainless steel door.

Unit Size:
 14¹/₄" x 28" x 4¹/₂"
 (362 x 711 x 114 mm)

Wall Opening:
 12³/₄" x 26¹/₂" x 4¹/₄"
 (324 x 673 x 108 mm)



6474
SIMPLICITY™ RECESSED WASTE RECEPTACLE

Stainless steel waste receptacle holds 12 gal. (46 L) of washroom waste materials. 18 gauge stainless steel door.

MODEL OPTIONS:
NEW 6474-41PC Matte Black.
6474-2 Semi-recessed with a stainless steel collar.
NEW 6474-2-41PC Matte Black.

Unit Size:
 17¹/₄" x 40" x 6³/₄"
 (438 x 1016 x 171 mm)

Wall Opening:
 15³/₄" x 38¹/₂" x 6¹/₄"
 (400 x 978 x 159 mm)



6468
**SIMPLICITY™ RECESSED DUAL NAPKIN/
 TAMPON VENDOR**

Dispenses 30 feminine napkins and 27 tampons. Universal coin mechanism allows for 25¢, 50¢, and free (no coin) operation. Choose appropriate suffix (-25, -50, or -F). Door has 2 tumbler locks, inside coin box has a separately keyed lock.

MODEL OPTION:
64684 designed for 4" (102 mm) wall opening; dispenses 15 napkins and 23 tampons.

Unit Size: 17¼" x 27¼" x 6½" (438 x 692 x 165 mm)	Wall Opening: 16" x 26" x 6¼" (406 x 660 x 159 mm)
--	---



68523A-4
**SIMPLICITY™ AUTOMATIC SEMI-RECESSED ROLL PAPER
 TOWEL DISPENSER**

Proximity sensing no-touch unit dispenses a pre-set length per cycle from 8" standard towel roll up to 800 ft. (244 m) long and has stub roll capability for continuous dispensing.

MODEL OPTION:
68523A battery operated, surface mounted.
68523AC roll towel dispenser, 110-240 VAC, surface mounted.
68523AC-4 roll towel dispenser, 110-240 VAC, semi-recessed.

Unit Size: 17⅞" x 20⅜" x 9½" (440 x 518 x 241 mm)	Wall Opening: 15⅝" x 19" x 4" (391 x 483 x 102 mm)
--	---

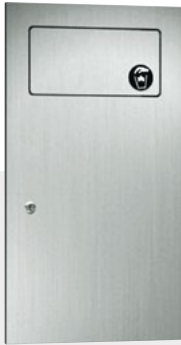

6471
**SIMPLICITY™ RECESSED
 SANITARY NAPKIN DISPOSAL**

Features a self-closing stainless steel push door that covers the disposal opening along with a removable 1.9 gal. (7.2 L) stainless steel waste receptacle. 18 gauge stainless steel door.

Unit Size: 10⅝" x 19⅞" x 4½" (270 x 498 x 114 mm)	Wall Opening: 9⅞" x 18⅞" x 4" (232 x 460 x 102 mm)
--	---

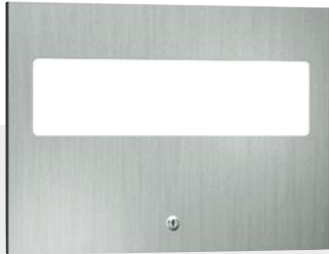

6477
**SIMPLICITY™ RECESSED TOILET SEAT
 COVER DISPENSER**

Dispenses 500 seat covers. 18 gauge stainless steel door.

Unit Size: 17¼" x 12¾" x 2⅞" (438 x 324 x 73 mm)	Wall Opening: 15¼" x 11½" x 2⅞" (400 x 292 x 60 mm)
---	--

SHOWN: 0469 PAPER TOWEL
DISPENSER AND
WASTE RECEPTACLE



TRADITIONAL™ COLLECTION

This time-honored collection provides exceptional value, offering a broad array of items for well-equipped washrooms. Double-pan doors incorporate a “no-flex” structural fiberboard core. Combining seamless construction and crisp design

lines, this elegant collection provides strength, comfort, beauty, and durability. All units have keyed-alike tumbler locks for ease in maintenance. Automatic dispensers feature a proximity sensor activated dispensing mechanism.

WHAT MAKES THE TRADITIONAL™ COLLECTION UNIQUE?

22

GAUGE

STAINLESS STEEL CONSTRUCTION

Fabricated with 22 gauge stainless steel with face trim, the recessed cabinet features one-piece construction with no miters or welding for durability.

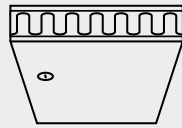

DOUBLE-PAN DOORS

The double-pan doors incorporate a “no-flex” structural fiberboard core, adding strength and endurance for long-term use.



SAFE EASY DISPENSING

Towel dispensers have hemmed opening for safe, easy dispensing, minimizing waste, and ensuring hygienic use.



EASY LIFT OUT RECEPTACLE

Fully removable stainless steel waste cans allow contents to be easily discarded for efficient ongoing maintenance and cleanliness.



MULTI-PURPOSE CABINETS



PAPER TOWEL DISPENSERS



WASTE RECEPTACLES



0462-AD
TRADITIONAL™ RECESSED PAPER TOWEL
DISPENSER AND WASTE RECEPTACLE

Dispenses 350 C-fold or 475 multi-fold paper towels.
 2 gal. (7.6 L) waste receptacle. Door and cabinet
 fabricated of 22 gauge stainless steel.

MODEL OPTION:

0462-AD-9 Surface mounted with a stainless
 steel collar.

Unit Size:

14¹/₄" x 28" x 4¹/₄"
 (362 x 711 x 108 mm)

Wall Opening:

12³/₄" x 26¹/₂" x 4"
 (324 x 673 x 102 mm)



0469
TRADITIONAL™ RECESSED PAPER TOWEL
DISPENSER AND WASTE RECEPTACLE

Dispenses 600 C-fold or 800 multi-fold paper towels.
 12 gal. (46 L) stainless steel waste receptacle.
 Fabricated of 22 gauge stainless steel.

MODEL OPTIONS:

0469-2 Semi-recessed with a stainless steel collar.
0469-9 Surface mounted with a stainless steel collar.
0469-BL 18 gal. (68 L) waste receptacle. Projects 8"
 (205 mm) from wall.

Unit Size:

17¹/₄" x 56" x 4¹/₄"
 (438 x 1422 x 108 mm)

Wall Opening:

15³/₄" x 54¹/₂" x 4"
 (400 x 1384 x 102 mm)



04697
TRADITIONAL™ RECESSED PAPER TOWEL DISPENSER AND WASTE RECEPTACLE

Dispenses 600 C-fold, 800 multi-fold, or 1100 single-fold paper towels. 12 gal. (46 L) stainless steel waste receptacle. Fabricated of 22 gauge stainless steel.

MODEL OPTIONS:

- 04697-4** Semi-recessed with a stainless steel collar.
- 04697-9** Surface mounted with a stainless steel collar.
- 04697-BL** 18 gal. (68 L) waste receptacle, projects 4" (102 mm) from wall.

Unit Size:

17¼" x 56" x 7¼"
 (438 x 1422 x 184 mm)

Wall Opening:

15¾" x 54½" x 7¼"
 (400 x 1384 x 184 mm)



04692A
TRADITIONAL™ AUTOMATIC RECESSED ROLL PAPER TOWEL DISPENSER AND WASTE RECEPTACLE

Proximity sensing no-touch unit dispenses a pre-set length per cycle from 8" or 9" (205 or 230 mm) wide, 800 ft. (244 m) long rolls. Fabricated of 22 gauge stainless steel, 18 gauge door.

SUFFIX OPTIONS FOR POWER/MOUNTING:

[A, A-6, A-9, AC, AC-6, AC-9]

- A:** Powered by 4 D-size batteries (not included).
- AC:** Powered by AC plug-in adapter.
- 6:** Semi-recessed with a stainless steel collar.
- 9:** Surface mounted with a stainless steel collar.
- 04692:** Mechanical lever dispenser.

Unit Size:

17¼" x 56" x 10¼"
 (438 x 1422 x 260 mm)

Wall Opening:

15¾" x 54½" x 10"
 (400 x 1384 x 254 mm)



0467

TRADITIONAL™ RECESSED PAPER TOWEL DISPENSER AND WASTE RECEPTACLE

Dispenses 600 C-fold, 800 multi-fold, or 1100 single-fold paper towels. 7 gal. (26 L) stainless steel waste receptacle. Fabricated of 22 gauge stainless steel.

MODEL OPTIONS:

- 0467-2** Semi-recessed with a stainless steel collar.
- 0467-9** Surface mounted with a stainless steel collar.

Unit Size:

13" x 55" x 6½"
(330 x 1397 x 165 mm)

Wall Opening:

11½" x 53½" x 6¼"
(292 x 1359 x 159 mm)



046926

TRADITIONAL™ SEMI-RECESSED ROLL PAPER TOWEL DISPENSER AND WASTE RECEPTACLE

Dispenses single full width cut towel 12" (305 mm) long from pull-towel autocut dispenser. With manual override feed wheel on the side of the cabinet. 13.5 gal. (52 L) waste receptacle. Door and back fabricated of 18 gauge stainless steel.

Unit Size:

17¼" x 56" x 9¼"
(438 x 1422 x 235 mm)

Wall Opening:

15¾" x 54½" x 4"
(400 x 1384 x 102 mm)



046921A
TRADITIONAL™ AUTOMATIC RECESSED ROLL PAPER TOWEL DISPENSER AND WASTE RECEPTACLE

Proximity sensing no-touch recessed unit dispenses a pre-set length per cycle from 8" or 9" (205 or 230 mm) wide, 800 ft. (244 m) long rolls. 12 gal. (45.4 L) waste receptacle. Fabricated of 22 gauge stainless steel, 18 gauge door.

SUFFIX OPTIONS FOR POWER/MOUNTING:
[A, A-6, A-9, AC, AC-6, AC-9]

- A:** Powered by 4 D-size batteries (not included).
- AC:** Powered by AC plug-in adapter.
- 6:** Semi-recessed with a stainless steel collar.
- 9:** Surface mounted with a stainless steel collar.
- 046921:** Mechanical lever dispenser.

Unit Size: 17¼" x 56" x 10¼" (438 x 1422 x 260 mm)	Wall Opening: 15¾" x 54½" x 10¼" (400 x 1384 x 260 mm)
---	---



046924
TRADITIONAL™ RECESSED ROLL PAPER TOWEL DISPENSER AND WASTE RECEPTACLE

Unit mechanically dispenses 8" or 9" wide standard towel roll up to 800 ft. (244 m) long and has stub roll capability for continuous dispensing. 12 gal. (46 L) disposal capacity. A lever operated dispensing mechanism also supplied. Surface mounted with 9" stainless steel collar.

MODEL OPTIONS:
046924-9 Surface Mounted with a stainless steel collar.

Unit Size: 17¼" x 56" x 10¼" (438 x 1422 x 260 mm)	Wall Opening: 15¾" x 54½" x 4" (400 x 1384 x 102 mm)
---	---



0457
TRADITIONAL™ RECESSED PAPER TOWEL DISPENSER

Dispenses 350 C-fold or 500 multi-fold paper towels; well-suited for smaller washrooms with less space and traffic. Fabricated of 22 gauge stainless steel.

MODEL OPTION:
0457-9 Surface mounted with a stainless steel collar.

Unit Size: 12¾" x 17¼" x 4¼" (324 x 438 x 108 mm)	Wall Opening: 11¼" x 15¾" x 4" (286 x 400 x 102 mm)
---	---



0452
TRADITIONAL™ RECESSED PAPER TOWEL DISPENSER

Dispenses 600 C-fold or 800 multi-fold paper towels. Fabricated of 22 gauge stainless steel.

MODEL OPTION:
0452-9 Surface mounted with a stainless steel collar.

Unit Size: 14¼" x 28" x 4¼" (326 x 711 x 108 mm)	Wall Opening: 12¾" x 26½" x 4" (324 x 673 x 102 mm)
--	---



045210A
TRADITIONAL™ AUTOMATIC RECESSED ROLL PAPER TOWEL DISPENSER

Dispenses pre-set length from 8" or 9" wide rolls. Fabricated of 22 gauge stainless steel, 18 gauge door.

SUFFIX OPTIONS FOR POWER/MOUNTING:
[A, A-6, A-9, AC, AC-6, AC-9]

A: Powered by 4 D-size batteries (not included).

AC: Powered by AC plug-in adapter. -6: Semi-recessed with a stainless steel collar.

-9: Surface mounted with a stainless steel collar.

Unit Size: 17¼" x 28" x 10" (438 x 711 x 254 mm)	Wall Opening: 15¾" x 26½" x 10¼" (400 x 673 x 260 mm)
--	---



0458
TRADITIONAL™ SEMI-RECESSED WASTE RECEPTACLE

Stainless steel waste container locks into cabinet, removable for servicing. Fabricated of 22 gauge stainless steel.

MODEL OPTION:
0458-9 Surface mounted with a stainless steel collar.

Unit Size: 17¼" x 30½" x 8¼" (438 x 775 x 210 mm)	Wall Opening: 15¾" x 29" x (variable*) (400 x 737 mm)
---	---

*[0458 if 4" (102 mm) x 4" and 12 gals. (46 L); 0458-CX if ½" (13 mm) x 7½" (191 mm) and 12 gals. (46 L); 0458-DX if 8" (203 mm) x 4" (102 mm) and 18 gals. (68 L)]



04733
TRADITIONAL™ RECESSED WASTE RECEPTACLE

Self-closing panel covers the receptacle opening, removable 3 gal. (11.4 L) stainless steel waste receptacle. Fabricated of 22 gauge stainless steel.

Unit Size: 14¼" x 28" x 4½" (362 x 711 x 114 mm)	Wall Opening: 12¾" x 26½" x 4" (324 x 673 x 102 mm)
--	---



0210
TRADITIONAL™ SURFACE MOUNTED PAPER TOWEL DISPENSER

Fabricated of 22 gauge stainless steel, this unit dispenses 400 C-fold or 525 multi-fold paper towels without adjustment or adapters and is fitted with tumbler lock and heavy-duty stainless steel piano hinge.

MODEL OPTION:
NEW 0210-41 Matte Black.

Overall Dimensions:
 11½" x 14½" x 4"
 (282 x 371 x 101 mm)



0215
TRADITIONAL™ SURFACE MOUNTED PAPER TOWEL DISPENSER – PETITE

Dispenses 200 C-fold or 275 multi-fold paper towels; well-suited for low-traffic areas. Fabricated of 22 gauge stainless steel.

Overall Dimensions:
 11" x 8" x 4"
 (279 x 203 x 102 mm)



0439
TRADITIONAL™ RECESSED PAPER TOWEL DISPENSER

This cabinet has 2 push-up flaps for bottom-filling with towels and dispenses 600 C-fold or 800 multi-fold paper towels; designed to conceal the dispenser behind mirror or wall so only the towel tray opening is visible. Fabricated of 22 gauge stainless steel.

Note for Designers: Leave 6" min. (152 mm) clearance below towel tray opening for space to pull towels; units are installed before hanging mirror or applying finished wall.

Overall Dimensions:
 11½" x 18" x 4½"
 (292 x 457 x 108 mm)



8522
TRADITIONAL™ SURFACE MOUNTED ROLL PAPER TOWEL DISPENSER

Mechanical unit dispenses a pre-set length per cycle from 8" or 9" (205 or 230 mm) wide, 800 ft. (244 m) long rolls. Fabricated of 22 gauge stainless steel, 18 gauge door. Product allows for modular retrofit into a variety of standard size cabinets.

MODEL OPTIONS:
8523A Powered by 4 D-size batteries (not included).
8523AC Powered by AC plug-in adapter.

Overall Dimensions:
 14" x 16" x 9½"
 (356 x 406 x 241 mm)



8165
TRADITIONAL™ SURFACE MOUNTED ROLL PAPER TOWEL DISPENSER

Holds standard paper towel roll up to 6" (152 mm) diameter; heavy-duty aluminum casting with satin-matte, silver-grey finish. Designed for controlled delivery of towels, and its concealed locking device on molded plastic spindle prevents theft.

Overall Dimensions:
 Unit measures 13" (330 mm) wide; projects 6" (152 mm) from wall.



0245-SS
TRADITIONAL™ SURFACE MOUNTED PAPER TOWEL DISPENSER

Fabricated of 22 gauge stainless steel. This unit dispenses 400 single-fold paper towels.

Overall Dimensions:
 11¼" x 6¼" x 5⅝"
 (285 x 160 x 143 mm)



0829
**TRADITIONAL™ CORNER
WASTE RECEPTACLE**

Fabricated of 22 gauge stainless steel with hemmed top and bottom edges for safety; capacity of 16 gal. (60 L) of waste.

Overall Dimensions:
15" x 23" x 14½"
(381 x 584 x 368 mm)



NEW



0834
**TRADITIONAL™ FREESTANDING
WASTE RECEPTACLE**

Fabricated of 22 gauge stainless steel; holds 14 gallons (54 L) of waste. Top is removable for easy maintenance and bottom is equipped with four (4) non-skid rubber feet.

MODEL OPTION:
0839 has 19 gal. (72 L) capacity with 12¾" x 32" x 12½" (314 x 800 x 318 mm) dimensions.

Overall Dimensions:
12¾" x 24" x 12½"
(314 x 609 x 318 mm)



NEW



0834-T
**TRADITIONAL™ FREESTANDING
WASTE RECEPTACLE WITH DUAL
SWING TOP**

Fabricated of 22 gauge stainless steel; holds 14 gallons (54 L) of waste. Top has dual swing door and is removable for easy maintenance. Bottom is equipped with four (4) non-skid rubber feet.

MODEL OPTION:
0839-T has 19 gal. (72 L) capacity with 12¾" x 37¼" x 12½" (314 x 946 x 318 mm) dimensions.

Overall Dimensions:
12¾" x 29¾" x 12½"
(314 x 756 x 318 mm)



0827
**TRADITIONAL™ SURFACE
MOUNTED WASTE RECEPTACLE**

Fabricated of 22 gauge stainless steel with hemmed top and bottom edges for safety; capacity of 2 gal. (7.6 L) of waste.

Overall Dimensions:
10½" x 9" x 4¾"
(267 x 229 x 121 mm)



0828
**TRADITIONAL™ SURFACE MOUNTED
WASTE RECEPTACLE**

Fabricated of 22 gauge stainless steel with hemmed top and bottom edges for safety; holds 6.5 gal. (24.8 L) of waste.

Overall Dimensions:
14" x 18" x 6"
(356 x 457 x 152 mm)



0825
**TRADITIONAL™ SURFACE
MOUNTED WASTE RECEPTACLE**

Fabricated of 22 gauge stainless steel; holds 17 gal. (64 L) with top and bottom hemmed edges; interior hooks for liner.

MODEL OPTION:
0826 has 12 gal. (45.4 L) capacity with 15¼" x 23" x 8" (387 x 584 x 203 mm) dimensions.

Overall Dimensions:
15¾" x 21¾" x 11¾"
(400 x 556 x 298 mm)



1000
TRADITIONAL™ CIRCULAR COUNTER TOP WASTE CHUTE

Provides waste deposit access to receptacle (not furnished) placed directly below chute; made of heavy gauge stainless steel with rolled flange and exposed surfaces that have satin finish.

MODEL OPTION:
1000A has a 9" (229 mm) outside diameter with a counter opening of 8 1/8" (206 mm) diameter.

Unit Size: 6 3/4" (171 mm) outside diameter	Counter Opening: 5 3/4" (146 mm) diameter
--	--



1001
TRADITIONAL™ COUNTER TOP MOUNTED PAPER TOWEL DISPENSER/WASTE RECEPTACLE

Capacity of 1 package of C-fold paper towels for loading by pushing through hinged dispensing flaps. Loose waste receptacle to be placed directly below waste door on the vanity floor. Capacity is 7.5 gal. (28 L).

Unit Size: 14 1/4" x 15" x 3/32" (362 x 381 x 2 mm)	Counter Opening: 12 1/2" x 13 1/2" (318 x 343 mm)
--	--



1002
TRADITIONAL™ COUNTER TOP MOUNTED PAPER TOWEL DISPENSER

Capacity of 1 package of C-fold paper towels for loading by pushing downward through hinged dispensing flaps.

Unit Size: 14 1/4" x 6" x 3/32" (362 x 152 x 2 mm)	Counter Opening: 12 1/2" x 4 1/4" (318 x 108 mm)
---	---



1003
TRADITIONAL™ COUNTER TOP MOUNTED WASTE RECEPTACLE

Push door is self-closing. A 12" x 12" x 12" (305 x 305 x 305 mm) waste receptacle is furnished to be placed directly below waste door on the vanity floor.

Unit Size: 14 1/4" x 10" x 3/32" (362 x 254 x 2 mm)	Counter Opening: 8 3/4" x 12 1/2" (222 x 318 mm)
--	---

SHOWN FROM LEFT: 0196-00 TURBO-PRO™ - WHITE
0196-41 TURBO-PRO™ - MATTE BLACK
0196-93 TURBO-PRO™ - STAINLESS STEEL
HIGH-SPEED ADA HAND DRYERS



TURBO-PRO™ AUTOMATIC HAND DRYER

Introducing ASI's Elegant ADA-Compliant, High-Speed, Automatic Hand Dryer. A HEPA filter is used to purify the air before it dries hands. The replaceable filter is housed in a separate chamber, which allows it to be easily accessed for removal without the need to disconnect the dryer.

The dryer provides operating flexibility—the owner controls air temperature as well as air speed to suit their needs and a 5-year warranty provides peace of mind. Available in Matte Black, White, or Satin finish Stainless Steel in 110-120 V or 208-240 V.

WHAT MAKES TURBO-PRO™ UNIQUE?

16
GAUGE

STAINLESS STEEL CONSTRUCTION

Our hand dryers are constructed of stainless steel, which is tough, durable, stain-resistant and easy to clean.



ADA ACCESSIBILITY STANDARD COMPLIANT

Our hand dryers are engineered to comply with the standards set forth by the American Disabilities Act for accessibility and safety.

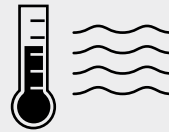

ADJUSTABLE AND FAST

The dryer provides operating flexibility—the owner controls air temperature as well as air speed to suit their needs.

HEPA
Filter

HEPA FILTER

A HEPA filter is used to purify the air before it dries hands.



TURBO-PRO™ AUTOMATIC HAND DRYER

0196-00 WHITE

0196-41 MATTE BLACK

0196-93 SATIN STAINLESS STEEL

FEATURES

- ADA compliant – ultra slim
- Ultra-hygienic – HEPA filter
- Energy efficient
- Quieter
- Fast drying
- Easy to maintain

VARIABLE SETTINGS

- Air flow can be lowered
- Heat can be turned on or off
- Save energy
- Reduce noise
- Gain operating flexibility

ELECTRIC

Different models for operating voltage

110-120 V (50/60 Hz),

220-240 V (50/60 Hz)

ON/OFF Heat Option

Nichrome Wire

325 – 500 W

DECIBEL LEVEL

68 to 73.8 dB-A @ 2M

DIMENSIONS

8 5/8" x 13 3/8" x 4"
(219 x 345 x 102 mm)



0198-MH
SAFE-DRI™ MENTAL HEALTH APPROVED RECESSED HIGH-SPEED HAND DRYER

Anti-ligature dryer designed for Behavioral Health environments—angled top, welded corners and single tube exhaust prevent looping, tying off, wedging, and prying. Tamper-resistant 18 gauge stainless steel cover and flush pin-hex security screws. Optional voltages available.

Unit Size: 12⁵/₁₆" x 15³/₄" x 5¹/₁₆"
 (320 x 400 x 140 mm)

Wall Opening: 11⁷/₁₆" x 14³/₄" x 5¹/₁₆"
 (303 x 376 x 130 mm)

Decibel Level: 66 dB-A @ 2M



20199
ROVAL™ SEMI-RECESSED HIGH-SPEED HAND DRYER

This high-performing hand dryer, with a drying time of 10-15 seconds, has a cover made of 18 gauge stainless steel. Available in 120 V (-1) and 240 V (-2).

Unit Size: 11" x 15¹/₂" x 5²³/₃₂"
 (279 x 394 x 145 mm)

Wall Opening: 10¹/₂" x 14⁵/₈" x 3¹/₄"
 (267 x 371 x 83 mm)

Decibel Level: 69 dB-A @ 2M

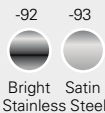

0197
TURBO-DRI™ HIGH-SPEED HAND DRYER

Fast drying, <15 seconds, and powerful, yet quiet, with 60-second auto shut off; automatic operation using infrared sensor with auto-resetting thermostat. Heavy-duty, one-piece-formed unit in bright or satin stainless steel finish, or white porcelain enamel coated steel. Available in 115-120 V (-1) and 208-240 V (-2).

Overall Dimensions:
 8¹/₁₆" x 11¹⁹/₆₄" x 7⁷/₆₄"
 (205 x 287 x 180 mm)

Decibel Level: 61.2-65.2 dB-A @ 2M

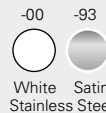

0199-1-41
ASITURBO-ADA ACCESSIBILITY COMPLIANT HIGH-SPEED HAND DRYER

Fast drying, <15 seconds, and automatic operation using infrared sensor with auto-resetting thermostat. Owner-adjustable air speed and temperature and on/off heating options with shut off when user removes hands from sensor zone. Standard white cover; optional bright or satin stainless steel finish. Available in 110-120 V (-1) and 208-240 V (-2).

Overall Dimensions:
 10⁵/₈" x 8¹⁵/₃₂" x 4"
 (270 x 215 x 102 mm)

Decibel Level: 68.9-74.3 dB-A @ 2M



ALL STAINLESS STEEL IS TYPE 304 WITH SATIN FINISH, UNLESS OTHERWISE NOTED.

*All Platto™ models require finished wall openings for installation. The edges of the finished wall opening are meant to be visible after installation, hence edges must be flat, square, straight, and plumb—no rough or unsightly edges.



-1-41

 Matte Black

NEW

0192 TURBO Swift™ ADA HIGH-SPEED HAND DRYER

High-speed ADA-compliant automatic hand dryer has one-piece stainless steel cover with satin finish and delivers eco-friendly and cost-saving performance. Includes adjustable infrared sensor, and LED indicates power status and guides user toward air flow. Fast drying, <12 seconds. 110-120 V.

Overall Dimensions:
 6²⁷/₃₂" x 10¹/₁₆" x 4"
 (174 x 256 x 102 mm)

Decibel Level: 74 dB-A @ 2M



-00 -93

 White Satin
 Stainless Steel

0196-41 TURBO-PRO™ HIGH-SPEED ADA HAND DRYER

Elegant ADA-compliant, high-speed, automatic hand dryer. A HEPA filter is used to purify the air before it dries hands. The dryer provides operating flexibility—the owner controls air temperature as well as air speed. Fast drying, <15 seconds. Available in 110-120 V (-1) and 208-240 V (-2).

Overall Dimensions:
 8⁵/₈" x 13³/₁₆" x 4"
 (219 x 345 x 102 mm)

Decibel Level: 68-73.8 dB-A @ 2M



0135-1 TURBO-TUFF™ RECESS MOUNTED HIGH-SPEED ADA HAND DRYER (110-120V)

Fast drying, less than 15 seconds, and automatic operation using infrared sensor with auto-resetting thermostat. Owner-adjustable air speed & temperature and on/off heating options with shut off when user removes hands from sensor zone. Satin Stainless Steel finish. Available in 208-240 V (-2) and 277 V (-3).

Unit Size: 12¹⁹/₃₂" x 15³/₄" x 4¹/₃₂"
 (320 x 400 x 102 mm) **Wall Opening:** 12⁵/₁₆" x 15³/₁₆" x 3⁷/₈"
 (313 x 386 x 98 mm)

Decibel Level: 68.9-74.3 dB-A @ 2M



-92

 Bright White
 Stainless Steel



0185 PROFILE™ HAND DRYER

Universal voltage; automatically adjusts to voltages of 100-240 V. Quick drying, <25 seconds, and no-touch, energy efficient operation. Modern design and durable. Cover available in one-piece steel with porcelain enamel coating, or stainless steel in bright or satin finish.

MODEL OPTION:
0184 Surface mounted no-touch hand dryer, 277 V.

Overall Dimensions:
 14⁷/₁₆" x 10¹³/₁₆" x 3¹⁵/₁₆"
 (367 x 275 x 100 mm)

Decibel Level: 69.2 dB-A @ 2M



64672-1
SIMPLICITY™ 3-IN-1
PAPER TOWEL DISPENSER, HIGH-
SPEED HAND DRYER, AND WASTE
RECEPTACLE

Paper towel dispenser with waste receptacle and <15 second automatic hand dryer, dispenses 500 standard multi-fold or 400 standard C-fold paper towels with a waste capacity of 6.8 gal. (26 L). Durable 20 gauge stainless steel cover has a satin finish. Dryer has 5-year warranty. 110-120 V. Available in 208-240 V (64672-2).

Unit Size:
 15³/₈" x 55³/₈" x 7¹/₂"
 (391 x 1407 x 191 mm)

Wall Opening:
 14³/₃₂" x 54³/₈" x 7¹/₄"
 (358 x 1381 x 184 mm)

Decibel Level: 68.9-74.3 dB-A @ 2M



64672-1-00
PIATTO™ COMPLETELY RECESSED
3-IN-1 PAPER TOWEL DISPENSER,
HIGH-SPEED HAND DRYER, AND
WASTE RECEPTACLE

This unit comes with a phenolic door and concealed hardware, and is designed to be *completely* recessed into the plane of the washroom wall. Features a <15 second automatic hand dryer, dispenses 400 standard C-fold or 500 standard multi-fold paper towels with a waste capacity of 6.8 gal. (26 L). Dryer has 5-year warranty. 110-120 V. Available in 208-240 V (-2). For matte black phenolic door use suffix -41, for white use -00.

Unit Size:
 15³/₈" x 55³/₈" x 7¹⁷/₃₂"
 (391 x 1407 x 191 mm)

Finished Wall Opening*:
 15⁷/₁₆" x 55⁷/₁₆" x 7⁹/₈"
 (392 x 1408 x 194 mm)

Decibel Level: 68.9-74.3 dB-A @ 2M



64672-1-41
PIATTO™ COMPLETELY RECESSED
3-IN-1 PAPER TOWEL DISPENSER,
HIGH-SPEED HAND DRYER,
AND WASTE RECEPTACLE

This unit comes with a phenolic door and concealed hardware, and is designed to be *completely* recessed into the plane of the washroom wall. Features a <15 second automatic hand dryer, dispenses 400 standard C-fold or 500 standard multi-fold paper towels with a waste capacity of 6.8 gal. (26 L). Dryer has 5-year warranty. 110-120 V. Available in 208-240 V (-2). For matte black phenolic door use suffix -41, for white use -00.

Unit Size:
 15³/₈" x 55³/₈" x 7¹⁷/₃₂"
 (391 x 1407 x 191 mm)

Finished Wall Opening*:
 15⁷/₁₆" x 55⁷/₁₆" x 7⁹/₈"
 (392 x 1408 x 194 mm)

Decibel Level: 68.9-74.3 dB-A @ 2M





0661-1
VELARE™ STAINLESS STEEL CABINET WITH
FRAMELESS MIRROR, LIQUID SOAP DISPENSER,
AND HIGH-SPEED HAND DRYER (110-120 V)

This wall mounted stainless steel cabinet conceals a hands-free automatic liquid soap dispenser with a .4 gal. (1.5 L) capacity and a high-speed hand dryer (110-120 V) equipped with a HEPA filter. Available in 208-240 V (0661-2).

Overall Dimensions:
 23⁵/₈" x 35⁷/₁₆" x 7⁹/₁₆"
 (600 x 900 x 192 mm)

Decibel Level: 68-73.8 dB-A @ 2M



0663-1
VELARE™ STAINLESS STEEL CABINET WITH
FRAMELESS MIRROR, FOAM SOAP DISPENSER,
AND HIGH-SPEED HAND DRYER (110-120 V)

This wall mounted stainless steel cabinet conceals a hands-free automatic foam soap dispenser with a .4 gal. (1.5 L) capacity and a high-speed hand dryer (110-120 V) equipped with a HEPA filter. Available in 208-240 V (0663-2).

Overall Dimensions:
 23⁵/₈" x 35⁷/₁₆" x 7⁹/₁₆"
 (600 x 900 x 192 mm)

Decibel Level: 68-73.8 dB-A @ 2M



0661-T
VELARE™ STAINLESS STEEL CABINET
WITH LIQUID SOAP DISPENSER, AND
PAPER TOWEL DISPENSER

This wall mounted stainless steel cabinet conceals a hands-free automatic liquid soap dispenser with a .4 gal. (1.5 L) capacity and paper towel dispenser with a 500 towel capacity.

Overall Dimensions:
 23⁵/₈" x 35⁷/₁₆" x 7⁹/₁₆"
 (600 x 900 x 192 mm)



0663-T
VELARE™ STAINLESS STEEL CABINET WITH
FRAMELESS MIRROR, FOAM SOAP DISPENSER,
AND PAPER TOWEL DISPENSER

This wall mounted stainless steel cabinet conceals a hands-free automatic foam soap dispenser with a .4 gal. (1.5 L) capacity and paper towel dispenser with a 500 towel capacity.

Overall Dimensions:
 23⁵/₈" x 35⁷/₁₆" x 7⁹/₁₆"
 (600 x 900 x 192)



Top Fill Multi-Feed Soap Dispensing System

SHOWN FROM LEFT: 0394-1AC-41 EZ FILL™ FOAM SOAP DISPENSER – MATTE BLACK, 0397-1AC EZ FILL™ WATER FAUCET – CHROME, 0394-1AC EZ FILL™ FOAM SOAP DISPENSER – CHROME, AND 0389-1AC TOP FILL MULTI-FEED FOAM SOAP DISPENSER – SATIN FINISH

WHAT MAKES OUR TOP FILL SOAP DISPENSING SYSTEMS UNIQUE?

UPTO
6
DISPENSERS

MULTI-FEED SYSTEM

Using infrared sensors, each of up to 6 automatic soap dispensers is fed by its own controllable peristaltic pump.

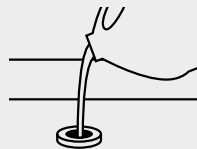

EASY REFILL

Using a single soap reservoir, this top fill system allows refill of soap dispensers with 1 pour—for easy ongoing maintenance.



UNIVERSAL REMOTE

Controls all dispensers with one remote, allowing flexibility in settings with a choice of 4 presets.

UPTO
6
LITER CAPACITY

RANGE OF SIZES FOR ALL NEEDS

Holds 6 L of liquid soap to supply up to six (6) individual EZ FILL™ vanity mounted automatic soap dispenser units.

0388 & 0389 TOP FILL MULTI-FEED SYSTEM (UP TO 12*)

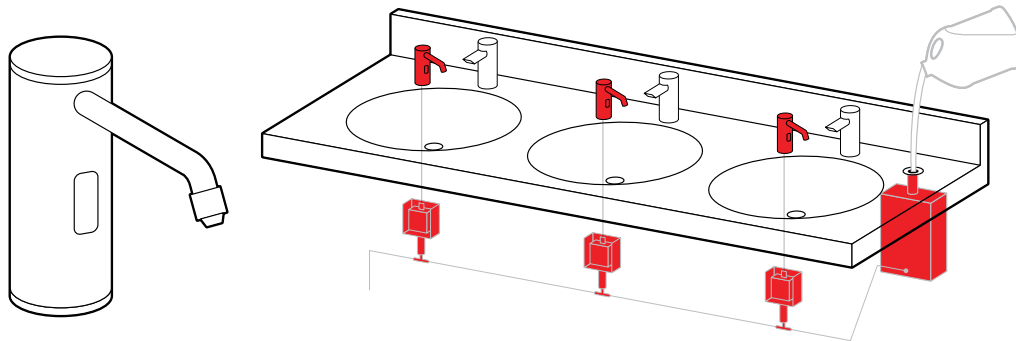

Soap Heads	Model		Soap Heads	Model	
 LIQUID	0387	Top Fill, Multi-Feed – Vanity Mounted Fill Port w/ 6L Under Vanity Tank	 FOAM	0387	Top Fill, Multi-Feed – Vanity Mounted Fill Port w/ 6L Under Vanity Tank
	0388-1A	Top Fill, Multi-Feed Liquid Soap Dispenser (Batt. not incl.) Satin Finish		0389-1A	Top Fill, Multi-Feed Foam Soap Dispenser (Batt. not incl.) Satin Finish
	0388-1AC	Top Fill, Multi-Feed Liquid Soap Dispenser (AC) Satin Finish		0389-1AC	Top Fill, Multi-Feed Foam Soap Dispenser (AC) Satin Finish

*Max 6 dispensers on each side of tank. For proper installation refer to owner's manual.

EZ FILL™ INDIVIDUAL

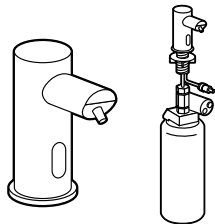

Individual vanity mounted automatic soap dispenser is refilled by removing 1 liter bottle from EZ FILL™ bracket under the counter.

EZ FILL™ MULTI-FEED SYSTEM (UP TO 6)

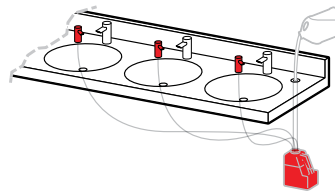

Refill up to six soap dispensers with one pour.

Soap Heads	Individual Chrome	6 Pack SKU ¹	Individual Matte Black	6 Pack SKU ¹	Soap Heads	Multi-Feed Chrome	6 Pack SKU ¹	Multi-Feed Matte Black	6 Pack SKU ¹
 LIQUID	0391-1AC	0391-6-1AC	0391-1AC-41	0391-6-1AC-41	 LIQUID	0390-1AC	0390-6-1AC	0390-1AC-41	0390-6-1AC-41
	0391-1A	0391-6-1A	0391-1A-41	0391-6-1A-41		0390-1A	0390-6-1A	0390-1A-41	0390-6-1A-41
 FOAM	0394-1AC	0394-6-1AC	0394-1AC-41	0394-6-1AC-41	 FOAM	0393-1AC	0393-6-1AC	0393-1AC-41	0393-6-1AC-41
	0394-1A	0394-6-1A	0394-1A-41	0394-6-1A-41		0393-1A	0393-6-1A	0393-1A-41	0393-6-1A-41
Faucets					TOP FILL, MULTI-FEED SYSTEM REQUIRES (A) AND (B)				
CHROME	0397-1AC	(A) 0390 - Multi-Feed Kit ³ – Kit ³ includes a 6 Liter Soap Container, Top Fill Tube and Counter Fill Port with Cover			(B) Multi-Feed – Soap Dispenser Head(s) ⁴				
	0397-1A								
MATTE BLACK	0397-1AC-41	0390-BR- Optional Under Counter Mounting Bracket for 6 Liter Container			0390-ARK- Anti-Rotation Kit for all 0390 Series				
	0397-1A-41	0390-R- Remote Control ¹ to adjust liquid dispensing settings			0393-R- Remote Control ¹ to adjust foam dispensing settings				
<p style="text-align: center;"><i>Stand Alone Dispensers come standard with 1 Liter soap container</i></p>									

¹ One Remote Control provided at no charge, with the 6 Pack SKU
² Powered by 6 D-size batteries (not included)

³ Kit does not include soap dispenser heads
⁴ Soap Dispenser Heads do not come with Multi-Feed Kit



0362-41
AUTOMATIC SURFACE MOUNTED LIQUID SOAP AND GEL HAND SANITIZER DISPENSER – MATTE BLACK

Stainless steel liquid soap and gel hand sanitizer dispenser with matte black finish and proximity sensor. Powered by 6 AA-size batteries (not included) and has a tamper-resistant sight gauge. Capacity: 27 oz. (0.8 L).

Overall Dimensions:
 4¹³/₁₆" x 10⁵/₈" x 4¹/₈"
 (122 x 270 x 105 mm)



0397
EZ FILL™ WATER FAUCET – CHROME

Matching water faucet for EZ Fill™ Top Fill Multi-Feed soap dispensing system. Battery or AC power operated, hands-free sensor housing with a highly polished chrome or matte black (-41) finish over all surfaces.

MODEL OPTION:
0397-1AC-41 Matte Black.



0362
AUTOMATIC SURFACE MOUNTED LIQUID SOAP AND GEL HAND SANITIZER DISPENSER – SATIN

Stainless steel liquid soap and gel hand sanitizer dispenser with satin finish and proximity sensor. Powered by 6 AA-size batteries (not included) and has a tamper-resistant sight gauge. Capacity: 27 oz. (0.8 L).

MODEL OPTION:
0362-41 Matte Black.

Overall Dimensions:
 4¹³/₁₆" x 10⁵/₈" x 4¹/₈"
 (122 x 270 x 105 mm)



0360
AUTOMATIC SURFACE MOUNTED LIQUID SOAP AND GEL HAND SANITIZER DISPENSER

Stainless steel liquid soap and gel hand sanitizer dispenser with satin finish and proximity sensor. Powered by 6 AA-size batteries (not included) and has a tamper-resistant sight gauge, removable lid with special lock and key. Capacity: 34 fl. oz. (1 L).

Overall Dimensions:
 4¹/₃₂" x 9¹/₄" x 4⁷/₈"
 (115 x 235 x 124 mm)

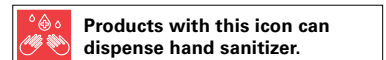



0334-S
AUTOMATIC VANITY MOUNTED LIQUID SOAP AND GEL HAND SANITIZER DISPENSER

Hands-free dispenser powered by 4 AA-size batteries (not included) or optional AC adapter (72-ACA, not included). Stainless steel body, all exposed stainless steel surfaces have a satin finish. Capacity: 50.7 oz. (1500 ml).

MODEL OPTION:
0334-B Stainless steel with bright finish.

Unit Size:
1½" x 3¼" (38 x 97 mm)
(dispenser body only)

Spout projection: 3⅞" (98 mm)



0335-B
AUTOMATIC VANITY MOUNTED FOAM SOAP AND HAND SANITIZER DISPENSER

Hands-free dispenser powered by 4 AA-size batteries (not included) or optional AC adapter (72-ACA, not included). Stainless steel body, all exposed stainless steel surfaces have a bright finish. Capacity: 50.7 oz. (1500 ml).

MODEL OPTION:
0335-S Stainless steel with satin finish.

Unit Size:
1½" x 3¼" (38 x 97 mm)
(dispenser body only)

Spout projection: 3⅞" (98 mm)



0338
TOP FILL AUTOMATIC VANITY MOUNTED LIQUID SOAP DISPENSER

Anti-theft top opens with funnel that has built-in key for neat and easy maintenance. LED ring indicates low liquid soap levels and incorrect soap. Smart Sensor prevents messy overfilling by beeping and flashing LED ring. AC Powered, 51 oz. (1.5 L) capacity.

Unit Size:
1½" x 5⅝" (38 x 137 mm)
(dispenser body only)

Spout projection: 3⅞" (98 mm)



0339
TOP FILL AUTOMATIC VANITY MOUNTED FOAM SOAP DISPENSER

Anti-theft top opens with funnel that has built-in key for neat and easy maintenance. LED ring indicates low foam soap levels and incorrect soap. Smart Sensor prevents messy overfilling by beeping and flashing LED ring. AC Powered, 51 oz. (1.5 L) capacity.

Unit Size:
1½" x 5⅝" (38 x 137 mm)
(dispenser body only)

Spout projection: 3⅞" (98 mm)



20333
AUTOMATIC VANITY MOUNTED LIQUID SOAP DISPENSER

Unit has chrome plated brass on exposed surfaces. Powered by 4 D-size batteries (not included). LEDs indicate function, battery condition, and soap supply level on face front. Translucent tank. Capacity: 54 oz. (1.6 L) of liquid soap.

Overall Dimensions:

4" x 2 1/2"
 (102 x 546 mm)

Spout Projection: 3 7/8" (99 mm)



20334
AUTOMATIC VANITY MOUNTED FOAM SOAP DISPENSER

Unit has chrome plated brass on exposed surfaces. Powered by 4 D-size batteries (not included). LEDs indicate function, battery condition, and soap supply level on face front. Translucent tank. Capacity: 54 oz. (1.6 L) of foam soap.

Overall Dimensions:

6 3/4" x 16"
 (172 x 407 mm)

Spout Projection: 3 7/8" (99 mm)



0332
VANITY MOUNTED MANUAL LIQUID SOAP DISPENSER

Corrosion-resistant valve with stainless steel spout and chrome plated brass escutcheon plate.

MODEL OPTIONS:

	Capacity	Spout
0332	34 oz. (1.0 L)	4" (102 mm)
0332-C	20 oz. (0.6 L)	4" (102 mm)
0332-CD	20 oz. (0.6 L)	6" (152 mm)
0332-D	34 oz. (1.0 L)	6" (152 mm)

Unit Size:

3 1/16" x 10 21/32"
 (87 x 271 mm)



0336
VANITY MOUNTED MANUAL FOAM SOAP DISPENSER

Plunger cap, stem and body, spout, escutcheon, and base sleeve fabricated of stainless steel. Soap container is translucent, shatter-resistant HDPE with 34 oz. (1 L) capacity.

MODEL OPTION:

0336-D 6" (152 mm) spout projection.

Unit Size:

3 1/2" x 15 3/4"
 (87 x 271 mm)

Spout projection: 4" (102 mm)

= LIQUID	= FOAM	Products with this icon can dispense hand sanitizer.
----------	--------	--



20363
ROVAL™ SURFACE MOUNTED LIQUID SOAP DISPENSER

Push button operation, valve needs no more than 5 lbs. of pressure to actuate. Dispenses liquid soap Capacity: 57 oz. (1.7 L).

Overall Dimensions:
 5½" x 10¼" x 4"
 (139 x 274 x 102 mm)

Spout Projection: 15/16" (24 mm)



20364
ROVAL™ AUTOMATIC SURFACE MOUNTED LIQUID SOAP AND GEL HAND SANITIZER DISPENSER

Hands-free liquid soap and gel hand sanitizer dispenser powered by 6 AA-size batteries (not included). Seamless drawn stainless steel cover. Translucent removable internal tank for easy-to-view level. LED indicates adjustment and operation. Capacity: 34 oz. (1 L).

Overall Dimensions:
 5½" x 107/8" x 4"
 (140 x 276 x 102 mm)



20365
ROVAL™ AUTOMATIC SURFACE MOUNTED FOAM SOAP AND HAND SANITIZER DISPENSER

Hands-free foam soap and hand sanitizer dispenser powered by 6 AA-size batteries (not included). Seamless drawn stainless steel cover. Translucent removable internal tank for easy-to-view level. LED indicates adjustment and operation. Capacity: 34 oz. (1 L).

Overall Dimensions:
 5½" x 107/8" x 4"
 (140 x 276 x 102 mm)



5001-SS
DISPOSA-VALVE SURFACE MOUNTED LIQUID SOAP DISPENSER

Soap is forced through disposable valve by pulling a lever forward. Disposable cartridges are available to dispense soap, hand lotion, heavy-duty cleaner, waterless cleaner, and antiseptic soap and are typically good for 1500 washings. Typical soap cartridges are super-concentrated cleansing formula approved for medical and food handling facilities. Fabricated of stainless steel.

Overall Dimensions:
 4¼" x 11" x 4"
 (108 x 279 x 102 mm)



0361
AUTOMATIC SURFACE MOUNTED LIQUID SOAP AND GEL HAND SANITIZER DISPENSER

White, high-impact plastic, proximity sensor, and powered by one 9 V or 6 AA-size batteries (not included). Tamper-resistant sight gauge, swing open body with special lock and key. Capacity: 28 fl. oz. (0.8 L).

Overall Dimensions:
 45/8" x 105/16" x 47/16"
 (118 x 262 x 113 mm)



0326
RECESSED HORIZONTAL LIQUID SOAP DISPENSER

Stainless steel with satin finish, all-purpose soap valve, 57 fl. oz. (1.7 L) liquid soap capacity. Includes tamper-resistant sight gauge.

Unit Size:
 10¼" x 6" x 4½"
 (260 x 152 x 115 mm)

Wall Opening:
 9" x 4⅞" x 4"
 (229 x 124 x 102 mm)
 Spout Projection: 2½" (64 mm)



9343
PROFILE™ SURFACE MOUNTED LIQUID SOAP DISPENSER

All-purpose valve dispenses liquid soap, with a capacity of 48 fl. oz. (1.4 L). It has a tamper-resistant sight gauge with concealed fastening and vandal-resistant hinged filler-top.

MODEL OPTION:
NEW 9343-41 Matte Black.

Overall Dimensions:
 7¼" x 6½" x 3⅛"
 (184 x 165 x 94 mm)
 Spout Projection: 1⅞" (24 mm)



0347
SURFACED MOUNTED VERTICAL LIQUID SOAP DISPENSER

0345
SURFACED MOUNTED HORIZONTAL LIQUID SOAP DISPENSER

40 fl. oz. (1.2 L) capacity liquid soap dispenser in stainless steel; satin finish comes with an all-purpose valve and a tamper-resistant sight gauge.

MODEL OPTIONS:
NEW 0347-41 Matte Black.
NEW 0345-41 Matte Black.

0347 Unit Size: 4⅜" x 8⅞" x 3⅞"
 (122 x 208 x 100 mm)
0345 Unit Size: 8⅞" x 4⅜" x 3⅞"
 (208 x 122 x 100 mm)

Spout projection: 1½" (38 mm)



NEW



0357
SURFACED MOUNTED HORIZONTAL FOAM SOAP DISPENSER

0359
SURFACED MOUNTED VERTICAL FOAM SOAP DISPENSER

40 fl. oz. (1.2 L) capacity foam soap dispenser in stainless steel; satin finish comes with an all-purpose valve and a tamper-resistant sight gauge.

0357 Unit Size:
 8⅞" x 4⅜" x 4½"
 (208 x 122 x 114 mm)

0359 Unit Size:
 4⅜" x 8⅞" x 4½"
 (122 x 208 x 114 mm)

Spout projection: 1½" (38 mm)

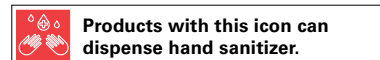



0661-1
VELARE™ STAINLESS STEEL CABINET WITH LIQUID SOAP DISPENSER AND HIGH-SPEED HAND DRYER

This wall mounted stainless steel cabinet conceals a hands-free automatic liquid soap dispenser with a .4 gal. (1.5 L) capacity and a high-speed hand dryer (110-120 V) equipped with a HEPA filter.

MODEL OPTION:
0661-2 Velare™ Stainless Steel Cabinet with Liquid Soap and Hand Dryer (208-240 V).

Overall Dimensions:
 23⁵/₁₆" x 35⁷/₁₆" x 7⁹/₁₆"
 (600 x 900 x 192 mm)



0663-1
VELARE™ STAINLESS STEEL CABINET WITH FOAM SOAP DISPENSER AND HIGH-SPEED HAND DRYER

This wall mounted stainless steel cabinet conceals a hands-free automatic foam soap dispenser with a .4 gal. (1.5 L) capacity and a high-speed hand dryer (110-120 V) equipped with a HEPA filter.

MODEL OPTION:
0663-2 Velare™ Stainless Steel Cabinet with Foam Soap and Hand Dryer (208-240 V).

Overall Dimensions:
 23⁵/₁₆" x 35⁷/₁₆" x 7⁹/₁₆"
 (600 x 900 x 192 mm)



0661-T
VELARE™ STAINLESS STEEL CABINET WITH LIQUID SOAP DISPENSER, AND PAPER TOWEL DISPENSER

This wall mounted stainless steel cabinet conceals a hands-free automatic liquid soap dispenser with a .4 gal. (1.5 L) capacity and paper towel dispenser with a 500 towel capacity.

Overall Dimensions:
 23⁵/₁₆" x 35⁷/₁₆" x 7⁹/₁₆"
 (600 x 900 x 192 mm)



0663-T
VELARE™ STAINLESS STEEL CABINET WITH FOAM SOAP DISPENSER, AND PAPER TOWEL DISPENSER

This wall mounted stainless steel cabinet conceals a hands-free automatic liquid soap dispenser with a .4 gal. (1.5 L) capacity and paper towel dispenser with a 500 towel capacity.

Overall Dimensions:
 23⁵/₁₆" x 35⁷/₁₆" x 7⁹/₁₆"
 (600 x 900 x 192 mm)



Sanitizing (NO) Touch Accessories

ASI offers a variety of (NO) Touch soap and hand sanitizer dispensers that can be placed where and when needed.

SHOWN: 20364 ROVAL™ AUTOMATIC SURFACE MOUNTED LIQUID SOAP AND GEL HAND SANITIZER DISPENSER

ASI (NO) Touch Automatic paper towel dispensers, combination units, and hand dryers can be found throughout this catalog.



0334-S
AUTOMATIC VANITY MOUNTED LIQUID SOAP AND GEL HAND SANITIZER DISPENSER

Hands-free dispenser powered by 4 AA-size batteries (not included) or optional AC adapter (72-ACA, not included). Stainless steel body, all exposed stainless steel surfaces have a satin finish. Capacity: 50.7 oz. (1500 ml).

MODEL OPTION:
0334-B Stainless steel with bright finish.

Unit Size:
 1½" x 3⅜" (38 x 97 mm)
 (dispenser body only)

Spout projection: 3⅞" (98 mm)



0335-B
AUTOMATIC VANITY MOUNTED FOAM SOAP AND HAND SANITIZER DISPENSER

Hands-free dispenser powered by 4 AA-size batteries (not included) or optional AC adapter (72-ACA, not included). Stainless steel body, all exposed stainless steel surfaces have a bright finish. Capacity: 50.7 oz. (1500 ml).

MODEL OPTION:
0335-S Stainless steel with satin finish.

Unit Size:
 1½" x 3⅜" (38 x 97 mm)
 (dispenser body only)

Spout projection: 3⅞" (98 mm)

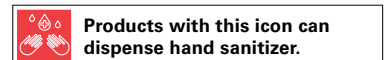



0360

AUTOMATIC SURFACE MOUNTED LIQUID SOAP AND GEL HAND SANITIZER DISPENSER

Stainless steel liquid soap and gel hand sanitizer dispenser with satin finish and proximity sensor. Powered by 6 AA-size batteries (not included) and has a tamper-resistant sight gauge, removable lid with special lock and key. Capacity: 34 fl. oz. (1 L).

Overall Dimensions:

4¹⁷/₃₂" x 9¹/₄" x 4⁷/₈"
(115 x 235 x 124 mm)



0361

AUTOMATIC SURFACE MOUNTED LIQUID SOAP AND GEL HAND SANITIZER DISPENSER

White, high-impact plastic, proximity sensor, and powered by one 9 V or 6 AA-size batteries (not included). Tamper-resistant sight gauge, swing open body with special lock and key. Capacity: 28 fl. oz. (0.8 L).

Overall Dimensions:

4⁵/₈" x 10⁵/₁₆" x 4⁷/₈"
(118 x 262 x 113 mm)



0362

AUTOMATIC SURFACE MOUNTED LIQUID SOAP AND GEL HAND SANITIZER DISPENSER – SATIN

Stainless steel liquid soap and gel hand sanitizer dispenser with satin finish and proximity sensor. Powered by 6 AA-size batteries (not included) and has a tamper-resistant sight gauge. Capacity: 27 oz. (0.8 L).

Overall Dimensions:

4¹³/₁₆" x 10⁵/₁₆" x 4¹/₈"
(122 x 270 x 105 mm)



0362-41

AUTOMATIC SURFACE MOUNTED LIQUID SOAP AND GEL HAND SANITIZER DISPENSER – MATTE BLACK

Stainless steel liquid soap and gel hand sanitizer dispenser with matte black finish and proximity sensor. Powered by 6 AA-size batteries (not included) and has a tamper-resistant sight gauge. Capacity: 27 oz. (0.8 L).

Overall Dimensions:

4¹³/₁₆" x 10⁵/₁₆" x 4¹/₈"
(122 x 270 x 105 mm)



20364

ROVAL™ AUTOMATIC SURFACE MOUNTED LIQUID SOAP AND GEL HAND SANITIZER DISPENSER

Hands-free liquid soap and gel hand sanitizer dispenser powered by 6 AA-size batteries (not included). Seamless drawn stainless steel cover. Translucent removable internal tank for easy-to-view level. LED indicates adjustment and operation. Capacity: 34 oz. (1 L).

Overall Dimensions:

5½" x 10⅞" x 4"
(140 x 276 x 102 mm)



20365

ROVAL™ AUTOMATIC SURFACE MOUNTED FOAM SOAP AND HAND SANITIZER DISPENSER

Hands-free foam soap and hand sanitizer dispenser powered by 6 AA-size batteries (not included). Seamless drawn stainless steel cover. Translucent removable internal tank for easy-to-view level. LED indicates adjustment and operation. Capacity: 34 oz. (1 L).

Overall Dimensions:

5½" x 10⅞" x 4"
(140 x 276 x 102 mm)

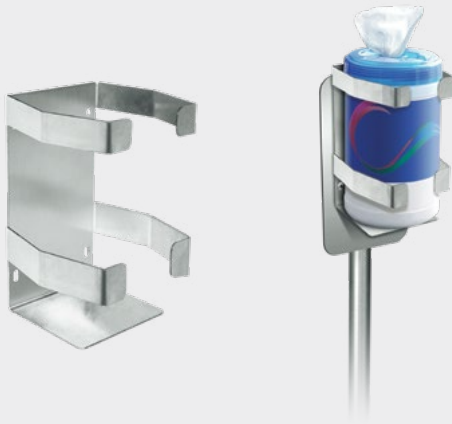

0502

WIPES DISPENSER HOLDER – ATTACHMENT FOR STANDS

Wipes dispenser holder mounts to stainless steel stands (sold separately) with self-threading pan head screws (by others) through holes provided or with double-sided tape with top of holder no higher than 46" above finished floor for ADA compliance. Constructed of 16 gauge stainless steel with satin finish. Holds one standard sized wipes tub (by others).

Overall Dimensions:

5²⁹/₆₄" x 8" x 5"
(139 x 203 x 127 mm)

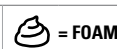
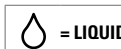

Products with this icon can dispense hand sanitizer.



Mirrors

ASI provides mirrors for every location, application, and budget—in virtually any size available. Choose from a variety of reflective surfaces and wall mountings, as well as styles ranging from frameless mirrors to mirrors with shelves and tilting features. Mirror silver guaranteed for 15 years.

SHOWN: 20650 ROVAL™ STAINLESS STEEL MIRROR

OPTIONAL REFLECTIVE SURFACES

SUFFIX DESCRIPTION:

- B Tempered Glass** ¼" (6 mm) polished tempered glass
- C Stainless Steel Mirrors** Type 304 Stainless Steel polished to a #8 mirror finish
- D Lexan Dura-Mir™** Fabricated of ¼" (6 mm) polycarbonate sheet
- E Plexiglas®** ¼" (6 mm) acrylic plastic, lightweight and shatter-resistant
- L Laminated Glass** ¼" (6 mm) thick

Note for Designers: All of the above glazing options are particularly suited to applications where frequent breakage and/or security problems exist. These surfaces are best specified for use in prisons, schools, police stations, psychiatric wards, etc., where shards of broken glass might possibly be used as weapons. The reflective quality of these types of mirrors is not as true as plate glass.



0620
CHANNEL FRAME MIRROR

½" x ½" (13 x 13 x 13 mm)
20 gauge type 304 satin finish stainless steel channel is a one-piece roll formed member that encases mirror and backing revealing a tight mitered corner. Mirror is installed on two wall brackets and held secure by theft-resistant screws.



0605
ANGLE FRAME MIRROR WITH SHELF

0625
CHANNEL FRAME MIRROR WITH SHELF

18 gauge stainless steel shelf with satin finish and all edges returned and hemmed for maximum rigidity and safety. Shelf is welded to face frame and is 5" (127 mm) deep.



0535
FIXED TILT MIRROR

Offers visibility for wheelchair patients. Frame fabricated of 20 gauge stainless steel with a satin finish. Mirror is tapered from 4" (102 mm) at top to 1" (25 mm) at bottom.



8026
FRAMELESS STAINLESS STEEL MIRROR

Fabricated of 20 gauge type 304 stainless steel polished to a #8 mirror finish with a ⅝" (8 mm) return. Provided with ¼" (6 mm) thick concealed tempered masonite backing and 4 mounting holes.



NEW



**0640
FRAMELESS MIRROR WITH
LED BACKLIGHT**

Frameless polished edge mirror with integral mounting frame and border LED halo lighting is made of 5/32" (4 mm) thick plate glass. Hard wired, concealed LED lighting system operates on 100/240 VAC 50/60 Hz and is turned on-off by an external wall switch (by others). Unit can be mounted horizontally or vertically without additional brackets or adaptations to mounting provisions.



NEW



**0641
FRAMELESS MIRROR WITH FROSTED
BORDER AND LED BACKLIGHT**

Frameless polished edge mirror with integral mounting frame and frosted glass border LED halo lighting is made of 5/32" (4 mm) thick plate glass. Hard wired, concealed LED lighting system operates on 100/240 VAC 50/60 Hz and is turned on-off by an external wall switch (by others). Unit can be mounted horizontally or vertically without additional brackets or adaptations to mounting provisions.



**0600
ANGLE FRAME MIRROR**

3/4" x 5/8" (19 x 16 mm) roll formed 18 gauge type 304 stainless steel angle has corners heliarc welded, ground and polished smooth to a uniform satin finish. Mirror is installed on a concealed hanging bracket that locks onto top and bottom of frame by tamper-proof set screws. Back plate is one-piece, attached to frame with theft-resistant locking device.

MODEL OPTION:
NEW 0600-41 Matte Black.



**20650
ROVAL™ STAINLESS STEEL MIRROR**

**20655
ROVAL™ STAINLESS STEEL MIRROR
WITH INTEGRAL SHELF**

Gently radiused edges match the ASI Roval™ design. Frame fabricated of 18 gauge type 304 stainless steel with satin finish and polished seamless mitered corners. 0.25" (6.4 mm) thick plate glass mirror.



**8287
FRAMELESS MIRROR**

Frameless mirrors offer clean lines to complement every type of interior design and are easy to care for. One-piece can be up to 28 sq. ft. (2.6 m²), as long as either H or W dimension is less than 84" (2134 mm). Mirrors larger than 28 sq. ft. (2.6 m²) or with either linear H or W dimension larger than 84" (2134 mm) shall be supplied as multiple pieces. Made of 1/4" polished plate glass.



**0600-T
ADJUSTABLE TILT MIRROR**

Designed to provide easy visibility for wheelchair patients or return to upright position. Angle frame fabricated of 18 gauge stainless steel with corners welded and ground smooth. Tilts a full 6" (152 mm) with bottom mounted on full width stainless steel piano hinge.

MIRRORS

STANDARD MIRROR SIZES														
Width x Height	0535	0537	0600	0600-T	0605	0620	0625	0640	0641	8026	20650	20650-B	20655	20655-B
16" x 20" (41 x 51 cm)			■		■	■				■				
16" x 24" (41 x 61 cm)			■	■	■	■	■			■				
16" x 30" (41 x 76 cm)	■	■	■	■		■								
18" x 24" (46 x 61 cm)	■		■	■	■	■	■			■				
18" x 30" (46 x 76 cm)	■	■	■	■	■	■	■			■	■	■	■	■
18" x 36" (46 x 91 cm)	■	■	■	■	■	■	■				■	■	■	■
20" x 60" (51 x 152 cm)			■			■								
24" x 24" (61 x 61 cm)						■								
24" x 30" (61 x 76 cm)	■		■		■	■	■			■				
24" x 36" (61 x 91 cm)	■		■	■	■	■	■	■	■	■	■	■	■	■
24" x 42" (61 x 107 cm)			■			■								
24" x 48" (61 x 122 cm)			■			■								
24" x 60" (61 x 152 cm)			■			■								
24" x 72" (61 x 183 cm)			■											
30" x 36" (76x 91 cm)			■			■		■	■					
30" x 48" (76x 122 cm)						■								
36" x 36" (91x 91 cm)			■			■								
36" x 48" (91 x 122 cm)						■								
48" x 30" (122 x 76 cm)			■		■	■								
48" x 36" (122 x 91 cm)			■		■	■		■	■					
60" x 24" (152 x 61 cm)			■		■	■								
60" x 36" (152 x 91 cm)			■		■	■		■	■					
72" x 36" (183 x 91 cm)			■		■	■								

Custom sizes available upon request. Standard glazing is glass. See optional reflective surfaces on page 72.



0661-1
VELARE™ STAINLESS STEEL CABINET WITH
FRAMELESS MIRROR, LIQUID SOAP DISPENSER,
AND HIGH-SPEED HAND DRYER (110-120 V)

This wall mounted stainless steel cabinet conceals a hands-free automatic liquid soap dispenser with a .4 gal. (1.5 L) capacity and a high-speed hand dryer (110-120 V) equipped with a HEPA filter.

MODEL OPTION:
0661-2 Velare™ Stainless Steel Cabinet with Liquid Soap and Hand Dryer (208-240 V).

Overall Dimensions:
 23⁵/₁₆" x 35⁷/₁₆" x 7⁹/₁₆"
 (600 x 900 x 192 mm)



0663-1
VELARE™ STAINLESS STEEL CABINET WITH
FRAMELESS MIRROR, FOAM SOAP DISPENSER,
AND HIGH-SPEED HAND DRYER (110-120 V)

This wall mounted stainless steel cabinet conceals a hands-free automatic foam soap dispenser with a .4 gal. (1.5 L) capacity and a high-speed hand dryer (110-120 V) equipped with a HEPA filter.

MODEL OPTION:
0663-2 Velare™ Stainless Steel Cabinet with Foam Soap and Hand Dryer (208-240 V).

Overall Dimensions:
 23⁵/₁₆" x 35⁷/₁₆" x 7⁹/₁₆"
 (600 x 900 x 192 mm)



0661-T
VELARE™ STAINLESS STEEL CABINET WITH
FRAMELESS MIRROR, LIQUID SOAP DISPENSER,
AND PAPER TOWEL DISPENSER

This wall mounted stainless steel cabinet conceals a hands-free automatic liquid soap dispenser with a .4 gal. (1.5 L) capacity and paper towel dispenser with a 500 towel capacity.

Overall Dimensions:
 23⁵/₁₆" x 35⁷/₁₆" x 7⁹/₁₆"
 (600 x 900 x 192 mm)



0663-T
VELARE™ STAINLESS STEEL CABINET WITH
FRAMELESS MIRROR, FOAM SOAP DISPENSER,
AND PAPER TOWEL DISPENSER

This wall mounted stainless steel cabinet conceals a hands-free automatic liquid soap dispenser with a .4 gal. (1.5 L) capacity and paper towel dispenser with a 500 towel capacity.

Overall Dimensions:
 23⁵/₁₆" x 35⁷/₁₆" x 7⁹/₁₆"
 (600 x 900 x 192 mm)



0661-FM-14
VELARE™ STAINLESS STEEL FRAMELESS MIRROR
FILLER MODULE

Wall mounted type 304 stainless steel cabinet filler module provides spacing between other Velare™ BTM modules where needed. Mirror is made from ¼" (6 mm) thick frameless tempered glass conforming to ASTM C-1048 with pencil edges and eased corners with SS sheet intermediate stiffener and SS back plate with integral welded support mounts.

Overall Dimensions:
 14¾" x 35⅞" x 7⅞"
 (375 x 900 x 192 mm)



0661-FM-23
VELARE™ STAINLESS STEEL FRAMELESS MIRROR
FILLER MODULE

Wall mounted type 304 stainless steel cabinet filler module provides spacing between other Velare™ BTM modules where needed. Mirror is made from ¼" (6 mm) thick frameless tempered glass conforming to ASTM C-1048 with pencil edges and eased corners with SS sheet intermediate stiffener and SS back plate with integral welded support mounts.

Overall Dimensions:
 23¼" x 35⅞" x 7⅞"
 (591 x 900 x 192 mm)

VELARE™ COLLECTION

ALL-IN-ONE CABINET HOUSES AN AUTOMATIC SOAP DISPENSER, AND YOUR CHOICE OF PAPER TOWEL DISPENSER OR HAND DRYER – NOW AVAILABLE WITH MIRROR FILLERS FOR FLEXIBILITY.

Backlit icons etched into the frameless mirror direct the user to their choice of soap and drying option. The self-contained design reduces hazards associated with wet floors. The ¼" thick tempered glass mirror, supported by twin, damped gas springs, opens up to 90° for easy maintenance.





Feminine Hygiene

ASI offers a wide range of feminine hygiene vendors and disposal units, available as recessed, semi-recessed, or surface mounted with various capacities. Type 304 stainless steel fabrication with satin finish on exposed surfaces and 18 gauge doors secured with concealed full length stainless steel hinges. Coin boxes are keyed separately from door lock for maximum security. Available for 25¢, 50¢, or free operation.

**SHOWN: 0468 RECESSED SANITARY
NAPKIN/TAMPON VENDOR**

FEMININE HYGIENE VENDORS AND DISPOSALS



0464

SEMI-RECESSED SANITARY NAPKIN & TAMPON VENDOR

Dispenses 30 feminine napkins and 27 tampons. Furnished with an adjustable flange for recessing in wall depths from 1" to 6" (26 to 152 mm). Universal coin mechanism allows for 25¢, 50¢, and free (no coin) operation. Choose appropriate suffix (-25, -50, or -F). Coin box has a separately keyed lock.

MODEL OPTION:

0864 Surface mounted.

Unit Size:

13³/₄" x 28¹/₂" x 6¹/₂"
(349 x 714 x 165 mm)

Wall Opening:

12¹/₂" x 26¹/₂" x 1" to 6"
(318 x 673 x 25 to 152 mm)



6468

SIMPLICITY™ RECESSED SANITARY NAPKIN & TAMPON VENDOR

Dispenses 30 feminine napkins and 27 tampons. Universal coin mechanism allows for 25¢, 50¢, and free (no coin) operation. Choose appropriate suffix (-25, -50, or -F). Its door has 2 tumbler locks. Coin box has a separately keyed lock.

MODEL OPTION:

64684 designed for 4" (102 mm) wall opening; dispenses 15 napkins and 23 tampons.

Unit Size:

17¹/₄" x 27¹/₄" x 6¹/₂"
(438 x 692 x 165 mm)

Wall Opening:

16" x 26" x 6¹/₄"
(406 x 660 x 159 mm)



0468

RECESSED SANITARY NAPKIN & TAMPON VENDOR

Dispenses 30 napkins and 27 tampons. Fabricated of 18 gauge stainless steel. Universal coin mechanism allows for 25¢, 50¢, and free (no coin) operation. Choose appropriate suffix (-25, -50, or -F).

MODEL OPTIONS:

0468-2 Semi-recessed with a stainless steel collar.

04684 Designed for 4" (102 mm) wall. Dispenses 15 napkins, 23 tampons.

Unit Size:

17¹/₄" x 27¹/₄" x 6¹/₂"
(438 x 692 x 165 mm)

Wall Opening:

16" x 26" x 6"
(406 x 660 x 152 mm)



204684

ROVAL™ RECESSED SANITARY NAPKIN & TAMPON VENDOR

Dispenses 31 napkins and 22 tampons. Door is 18 gauge satin finish stainless steel, with 2 flush tumbler locks. Universal coin mechanism allows for 25¢, 50¢, and free (no coin) operation. Choose appropriate suffix (-25, -50, or -F).

MODEL OPTION:

204684-9 Surface mounted with a stainless steel collar.

Unit Size:

17⁵/₁₆" x 27³/₄" x 5⁵/₈"
(440 x 705 x 143 mm)

Wall Opening:

15⁵/₈" x 26¹/₈" x 4"
(397 x 664 x 102 mm)



0472

PARTITION MOUNTED DUAL ACCESS NAPKIN DISPOSAL

Unit serves two compartments mounted in partitions. Receptacle removable from one side for servicing and locks to back of cabinet by means of stainless steel clips. Self-closing doors on each side are mounted to cabinet with heavy-duty full length piano hinge. 22 gauge stainless steel. Capacity: 1.5 gal. (5.7 L).

MODEL OPTION:

0472-1 Waste receptacle unit with lock.

Unit Size:	Partition Opening:
13" x 17¼" x 4"	11⅜" x 15⅝"
(330 x 438 x 102 mm)	(290 x 400 mm)



0473

RECESSED SANITARY NAPKIN DISPOSAL

Unit features self-closing door and is fabricated of 22 gauge stainless steel. Capacity: 1.5 gal. (5.7 L).

MODEL OPTION:

0473-1 Waste receptacle unit with lock.

Unit Size:	Wall Opening:
13" x 17¼" x 4¼"	11¼" x 15¼" x 4"
(330 x 438 x 108 mm)	(285 x 400 x 102 mm)



0473-A

SURFACE MOUNTED END STALL SANITARY NAPKIN DISPOSAL

Unit features self-closing door and is fabricated of 22 gauge stainless steel. Capacity: 1.5 gal. (5.7 L).

Overall Dimensions:

11" x 15¼" x 4"
(279 x 387 x 102 mm)



0473-1A

SURFACE MOUNTED END STALL SANITARY NAPKIN DISPOSAL WITH LOCK

Unit features self-closing door and is fabricated of 22 gauge stainless steel. Capacity: 1.5 gal. (5.7 L). Includes tumbler lock for servicing.

Overall Dimensions:

11" x 15¼" x 4"
(279 x 387 x 102 mm)



6471

SIMPLICITY™ RECESSED SANITARY NAPKIN DISPOSAL

Features a self-closing 20 gauge stainless steel push door that covers the disposal opening along with a removable 1.9 gal. (7.2 L) stainless steel waste receptacle.

Unit Size:
10⁵/₈" x 19⁵/₈" x 4¹/₂"
(270 x 498 x 114 mm)

Wall Opening:
9¹/₈" x 18¹/₈" x 4"
(232 x 460 x 102 mm)



0852

SURFACE MOUNTED SANITARY NAPKIN DISPOSAL

Sloping cover has full length piano hinge. Fabricated of 22 gauge stainless steel. Capacity: 1.2 gal. (4.5 L).

Overall Dimensions:
7⁷/₈" x 9¹/₁₆" x 4"
(200 x 246 x 102 mm)



20470

ROVAL™ RECESSED SANITARY NAPKIN DISPOSAL

Heavy-duty ⁵/₆₄" staked piano hinge adds to the robust construction. Drawn, one-piece seamless door of 22 gauge stainless steel with a satin finish. 1.0 gal. (3.8 L) waste capacity.

Overall Dimensions:
12¹³/₁₆" x 11" x 5⁷/₁₆"
(325 x 280 x 138 mm)



20852

ROVAL™ SURFACE MOUNTED SANITARY WASTE RECEPTACLE

Lid is drawn, one-piece construction and is secured to the cabinet with a heavy-duty ⁵/₆₄" multi-staked concealed piano hinge. Fabricated of 22 gauge stainless steel. Capacity: 1 gal. (3.8 L).

Overall Dimensions:
7¹/₄" x 10" x 3¹/₂"
(185 x 253 x 89 mm)



Specialty Accessories

With an extensive portfolio of washroom accessories, ASI can provide whatever you need to promote the neat and orderly use of your facilities. These designs reflect our attention to detail for durability and easy maintenance.

SHOWN: 0785-Z TOWEL RING

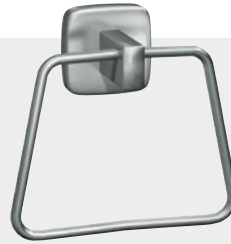

7385
TOWEL RING

For bath and hand towels. Ring is 4½" (114 mm) wide, made of ¼" (6 mm) diameter stainless steel bar. Projects 2½" (64 mm) from wall. 5" (127 mm) high.

MODEL OPTION:
NEW 7385-41 Matte Black.



8425
CLOTHES HOOK

Heavy-duty 11 gauge stainless steel with satin finish. Hook projects 1¼" (32 mm) from wall and is 2¼" (57 mm) high.



0714
COAT AND BUMPER HOOK

Fabricated from chrome plated brass, 3" (76 mm). Neoprene bumper protects wall surface.

0719
DOOR BUMPER

Chrome plated Zamac 2¾" (56 mm) diameter flange. Projects 1⅞" (48 mm).



0745-Z
DOUBLE ROBE HOOK

Fabricated from triple chrome plated rust-resistant Zamac.

MODEL OPTION:
0740-Z Single robe hook.

Overall Dimensions:
2¾" x 1⅞" x 1²⁹⁄₆₄"
(56 x 37 x 37 mm)



7340
SINGLE ROBE HOOK

Fabricated from stainless steel. Hook extends 2" (51 mm) from wall.

MODEL OPTION:
NEW 7340-41 Matte Black.



7345
DOUBLE ROBE HOOK

4" (102 mm) wide stainless steel bar forms hook at each end. Unit extends 2" (51 mm) from wall.



**7382
HAT AND COAT HOOK**

Double hook made from stainless steel for both coats and hats.

Overall Dimensions:
2" x 7" x 3"
(51 x 178 x 76 mm).



**0751
HEAVY-DUTY ROBE HOOK**

Concealed mounting satin chrome plated brass, projects 3/4" (84 mm).

MODEL OPTION:
0751-A Exposed mounting, satin chrome plated brass, projects 3/4" (83 mm).



**0785-Z
TOWEL RING**

Bracket formed of Zamac and towel ring formed of triple chrome plated corrosion-resistant steel.

Overall Dimensions:
6 3/8" x 1 5/8"
(162 x 41 mm)



**7301-B
TOWEL PIN**

Fabricated from stainless steel with bright finish.

Extends 3/2" (89 mm) from wall.

MODEL OPTION:
7301-S Towel pin with satin finish.

Overall Dimensions:
2" x 2" x 3 1/2"
(51 x 51 x 89 mm)



**0712
SURFACE-MOUNTED
RETRACTABLE CLOTHES LINE**

Polished stainless steel unit has spring actuated 72" (1829 mm) vinyl cord with white vinyl knob and locking nut to hold stretched line taut. Installs over bathtub or in shower.



**0002-SM
STAINLESS STEEL PAPER
CUP DISPENSER**

Dispenses 100 flat bottom cups. Adjustable for 3 oz. through 6 oz. cups. Stainless steel with bright finish.

Overall Dimensions:
3" Diameter x 15"
(76 x 381 mm)



**7320
SOAP DISH**

Drawn, one-piece stainless steel soap dish welded to support arm and flange. Has two drain holes and two ridges to support bar of soap.

MODEL OPTION:
0721-Z Fabricated from triple chrome plated rust-resistant Zamac.

Overall Dimensions:
4 1/4" x 2" x 4"
(108 x 51 x 102 mm)



**7335
TOOTHBRUSH AND
TUMBLER HOLDER**

Drawn, one-piece toothbrush holder is made of stainless steel. Has 2 1/4" (60 mm) diameter hole in center of unit to hold tumbler. Accommodates 6 toothbrushes.

MODEL OPTION:
0735-Z Fabricated from triple chrome plated rust-resistant Zamac.

Overall Dimensions:
4 1/4" x 2" x 4"
(108 x 51 x 102 mm)



**7355
TOWEL BAR-ROUND**

3/4" (19 mm) diameter stainless steel towel bar and stainless steel mounting bracket. Available in 18", 24", and 30" (457, 610, and 762 mm) lengths in bright (-B) and satin (-S) finishes. Extends 3 1/4" (83 mm) from wall

MODEL OPTION:
NEW 7355-24-41 24" Matte Black.



**0755-SS
HEAVY-DUTY STAINLESS
STEEL TOWEL BAR**

Towel bar fabricated of 1" (25 mm) O.D. x 20 gauge, stainless steel with a satin finish and designed not to turn in support posts. Support posts fabricated of heavy solid cast brass plated to have stainless steel satin finish to match stainless steel. Available in 18" and 24" (457, and 610 mm) lengths.

MODEL OPTION:
0755-Z Triple chrome plated rust proof Zamac brackets. Triple chrome plated steel tubing.



**0760-Z
SQUARE TOWEL BAR**

3/4" (19 mm) square 21 gauge triple chrome plated rust-resistant Zamac. Available in 18", 24", and 30" (457, 610, and 762 mm) lengths.

Fabricated from triple chrome plated rust-resistant Zamac.



**7310-B
TOWEL SHELF WITH
TOWEL BAR**

8" (203 mm) deep consisting of four 3/8" (10 mm) diameter bright finish stainless steel tubes, with 1/4" (6 mm) diameter bright finish stainless steel towel bar below shelf. Overall height: 4 1/4" (110 mm).

MODEL OPTION:
7310-S Towel shelf with satin finish.



**7311-B
TOWEL SHELF WITH
TOWEL BAR**

Heavy-duty unit with 3/4" (19 mm) diameter drying rod and 3/8" (10 mm) diameter cross tubes in stainless steel. Bright finish only. Available 20" (508 mm) and 24" (610 mm). Overall height: 6 1/2" (165 mm); projects 8" (203 mm).



**NEW
0503
HANDS-FREE ARM GRIP
DOOR PULL**

Hands-free arm grip door pull provides an alternative to open doors without having to use hands. Grip is surface mounted with self-threading flat head screws (by others) through holes provided, at standard mid-door height, or no higher than 40" above finished floor for ADA compliance, to allow placing the forearm to pull door open. Constructed of 11 gauge stainless steel with satin finish and fully deburred edges for user safety.

Overall Dimensions:
1 3/4" x 2 1/8" x 3"
(44 x 54 x 76 mm)



**NEW
0504
HANDS-FREE FOOT GRIP
DOOR PULL**

Hands-free foot grip door pull provides an alternative to open doors without having to use hands. Grip is surface mounted with self-threading flat head screws (by others) through holes provided, at base of door aligned with bottom edge or slightly above, and as close to opening side as possible. Constructed of 11 gauge stainless steel with satin finish and fully deburred edges for user safety.

Overall Dimensions:
3" x 3" x 2 9/64"
(76 x 76 x 54 mm)



**0258-SS
SURFACE MOUNTED FACIAL
TISSUE DISPENSER**

Fabricated of stainless steel with satin finish. Dispenses 300 single-ply or 150 two-ply sheets.



MODEL OPTION:
0259-SS A recessed version of the unit.

Overall Dimensions:
10 1/4" x 5 9/16" x 2 3/16"
(260 x 135 x 55 mm)



NEW



**04822
TOILET TISSUE DISPENSER/
NAPKIN DISPOSAL—RECESSED**

Holds and dispenses two (2) rolls standard or 1800 sheet 4-1/2" x 5-1/4" diameter (114 x Ø133) toilet paper. Removable waste container has a capacity of 1.3 gal (4.9 liters).

Toilet paper dispenser/disposal door is held closed with a tumbler lock. Cabinet includes two (2) chrome plated toilet tissue rollers [p/n R-003] (supplied).

Unit Size: 17 3/8" x 12 3/4" x 4 1/4" (438 x 324 x 108 mm)
Wall Opening: 15 3/4" x 11 1/8" x 4" (400 x 283 x 102 mm)



**048234
RECESSED MULTI-ROLL TOILET
TISSUE DISPENSER**

Holds and dispenses 4 rolls or 1800 sheets of standard toilet tissue.

Unit Size: 17 3/8" x 20" x 4 1/4" (441 x 508 x 108 mm)
Wall Opening: 15 3/4" x 18 3/8" x 4" (400 x 467 x 102 mm)



**0484
PARTITION MOUNTED DUAL ACCESS
SEAT COVER AND TOILET TISSUE
DISPENSER**

Mounts centered through partition. Internal baffles prevent line of sight view from either side through unit at any time. Holds and dispenses 1000 seat covers and 4 rolls or 1800 sheets of standard toilet paper.

MODEL OPTIONS:
0484-HC Mounts flush to partition.
0485 For end-stall installation.
0486 Surface mounted with a stainless steel collar.

Unit Size: 17 3/8" x 30 5/8" x 4 1/2" (441 x 778 x 114 mm)
Partition Opening: 15 1/2" x 28 7/8" x 1/2" to 2" (394 x 733 x 13 to 51 mm)



**04813
PARTITION MOUNTED DUAL ACCESS
TOILET TISSUE DISPENSER WITH
NAPKIN DISPOSAL**

Mounts through partition, usable by both sides but serviced from one side. Holds 4 rolls of toilet tissue.

MODEL OPTIONS:
04813-HC One side mounts flush.
04823 Holds two rolls, for end-stall installation.
04833 Surface mounted with a stainless steel collar.

Unit Size: 17 3/8" x 20" x 4 1/4" (441 x 508 x 108 mm)
Partition Opening: 15 1/2" x 18 1/4" (394 x 464 mm) adjustable for partitions in thickness from 1/2" to 2" (13 to 51 mm)



**0481
PARTITION MOUNTED DUAL ACCESS
SEAT COVER AND TOILET TISSUE
DISPENSER WITH SANITARY DISPOSAL**

Mounts through partition usable by both sides but serviced from one side. Holds 1000 seat covers and 4 rolls of toilet tissue.

MODEL OPTIONS:
0481-HC One side mounts flush.
0482 For end-stall installation.
0483 Surface mounted with a stainless steel collar.

Unit Size: 17 3/8" x 30 5/8" x 4 1/4" (441 x 778 x 108 mm)
Partition Opening: 15 1/2" x 28 7/8" (394 x 733 mm) adjustable for partitions in thickness from 1/2" to 2" (13 to 51 mm)



NEW



**0487-R
RECESSED ADA-COMPLIANT TOILET
TISSUE AND SEAT COVER DISPENSER
WITH WASTE DISPOSAL**

Recessed seat cover and toilet paper dispenser with sanitary napkin disposal. Holds 500 seat covers and 2 rolls of toilet tissue.

MODEL OPTIONS:
0487-L All components on opposite side.
0487-R-9 Surface mounted with a stainless steel collar.
0487-L-9 Surface mounted with a stainless steel collar, with all components on opposite side.

Unit Size: 28" x 14 1/4" x 4 1/4" (711 x 362 x 108 mm)
Wall Opening: 26 1/2" x 12 7/8" x 4 1/4" (673 x 327 x 108)

SHOWN: 74022-H TOILET TISSUE DISPENSER

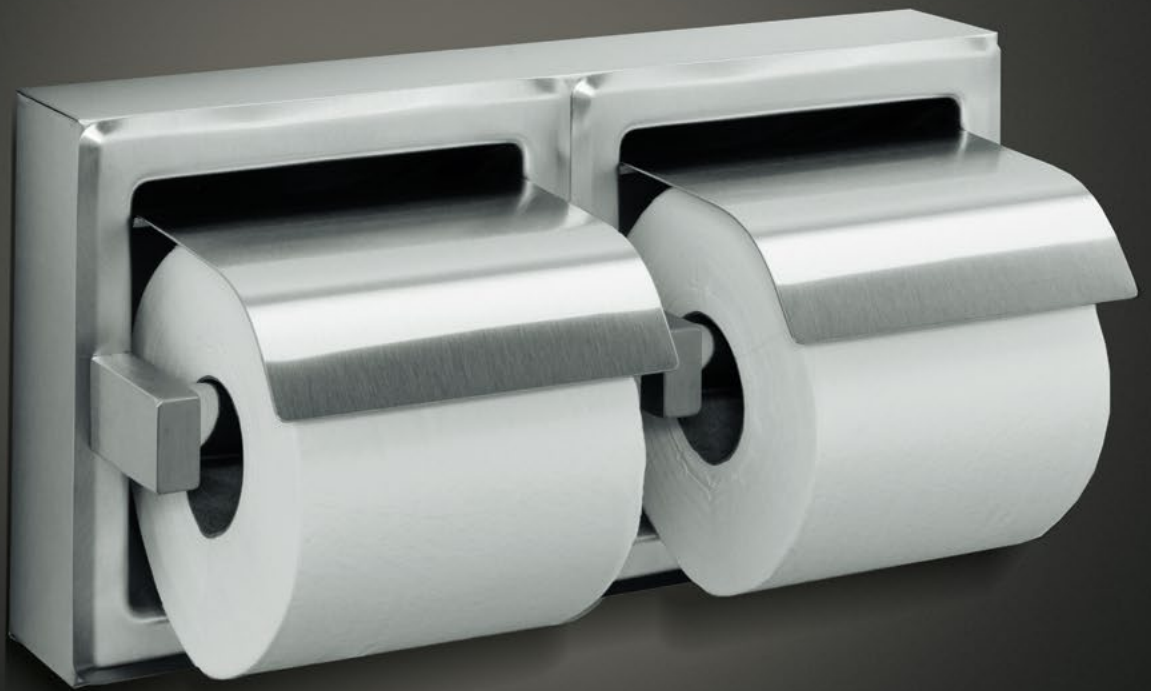

TOILET TISSUE DISPENSERS

ASI offers many different designs and styles to complement the features of your washroom setting. Engineered for heavy-duty use and easy maintenance, these units stand the test of time.

Choose from a wide range of features, based on your own washroom needs. All of these options are easy to install, easy to use, durable, and affordably priced.

WHAT MAKES THESE DISPENSERS UNIQUE?

18-22
GAUGE

STAINLESS STEEL CONSTRUCTION

Our dispensers are made of stainless steel, which is a tough, durable material that is stain-resistant and easy to clean.

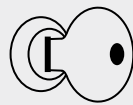

TUMBLER LOCKS

Our tumbler locks provide convenience and security with an elegant look.

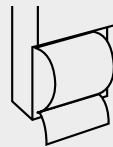

SAFE, EASY DISPENSING

Dispensing and storage options vary, from single roll to multiple rolls or jumbo roll dispensers.

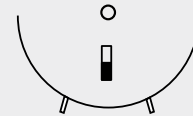

VIEWING SLOT

Slot in front cover of jumbo roll dispensers provides easy visual indication of remaining tissue supply.

SPINDLES:



R-002: THEFT-RESISTANT SPINDLE FOR 0263 AND 0264 SERIES (STANDARD)

FOR 0402-Z, 0697-GAL, 0705-Z AND VARIOUS 7000 SERIES UNITS



R-003: CHROME-PLATED SPINDLE (OPTIONAL)



R-009: THEFT-RESISTANT SPINDLE (OPTIONAL)

FOR 0030, 0031, 0032, 20030, 20031, AND ALL COMBINATION UNITS



R-005: SPINDLE FOR CORELESS ROLLS (OPTIONAL)



RECESSED ADA-COMPLIANT TOILET TISSUE AND SEAT COVER DISPENSER WITH WASTE DISPOSAL

See our Toilet Tissue Combination Units, page 79.



0030
SURFACE MOUNTED DUAL ROLL TOILET TISSUE DISPENSER

Holds two rolls up to 5¼" (133 mm) diameter (1800 sheets). Top roll automatically drops in place when bottom roll is used up. Stainless steel cabinet and mechanism. Theft-resistant spindles.

Unit Size:
 6" x 12" x 6½"
 (152 x 305 x 165 mm)



0030-41
MATTE BLACK TOILET TISSUE DISPENSER, TWIN HIDE-A-ROLL — SURFACE MOUNTED

Holds two rolls up to 5¼" (133 mm) diameter (1800 sheets). Top roll automatically drops in place when bottom roll is used up. Type 304 stainless steel cabinet and mechanism. Theft resistant spindles.

Unit Size:
 6" x 12" x 6½"
 (152 x 305 x 165 mm)



0032
PARTITION MOUNTED DUAL ACCESS DUAL ROLL TOILET TISSUE DISPENSER

Serves two toilet compartments by mounting through partition. Dispenses 4 toilet tissue rolls. Adjustable to accommodate partitions from ½" to 1¼" thick (13 to 32 mm).

Unit Size: 14" x 14⅞" x 10"
 (356 x 359 x 255 mm)
Partition Opening: 12⅞" x 12¼" x ½-2½"
 (308 x 311 x 13-64 mm)



0031
RECESSED DUAL ROLL TOILET TISSUE DISPENSER

Holds two rolls up to 5¼" (133 mm) diameter (1800 sheets). Top roll automatically drops in place when bottom roll is used up. Stainless steel cabinet and mechanism. Theft-resistant spindles. Includes stainless steel flange for recess mounting.

Unit Size: 8" x 14" x 6½"
 (203 x 356 x 165 mm)
Wall Opening: 6¼" x 12¼" x 3⅞"
 (159 x 311 x 86 mm)



0039
SURFACE MOUNTED LOW PROFILE TWIN 9" JUMBO ROLL TOILET TISSUE DISPENSER

Holds two 9" (229 mm) diameter rolls of 2¼" or 3" (57 or 76 mm) diameter core. When one roll is depleted, slide panel to expose other roll. Door cabinet and mounting plate fabricated of 18 gauge stainless steel with a satin finish. Door is hung on heavy-duty stainless steel pivot hinges. Equipped with tumbler lock.

Overall Dimensions:
 20½" x 11⅜" x 4⅛"
 (521 x 284 x 119 mm)



0040
SURFACE MOUNTED TWIN 9" JUMBO ROLL TOILET TISSUE DISPENSER

Holds two 9" (229 mm) diameter rolls of 2¼" or 3" (57 or 76 mm) diameter core. When one roll is depleted, slide panel to expose other roll. Door cabinet and mounting plate fabricated of 18 gauge stainless steel with a satin finish. Two viewing slots reveal toilet tissue rolls inside. Equipped with tumbler lock.

Overall Dimensions:
 20⅜" x 11⅜" x 6⅜"
 (529 x 289 x 157 mm)



0042
SURFACE MOUNTED JUMBO ROLL TOILET TISSUE DISPENSER

Holds one roll up to 10" (254 mm) diameter of 1½" or 2¼" (41 or 57 mm) diameter core. Outer cabinet is stainless steel with a satin finish. Unit has viewing slot and tumbler lock.

MODEL OPTION:
NEW 0042-41 Matte Black.

Overall Dimensions:
 10⅝" x 10⅝" x 4½"
 (270 x 270 x 114 mm)

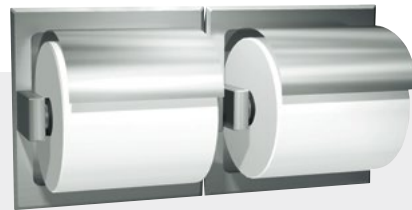

74022-H
RECESSED DOUBLE TOILET TISSUE HOLDER WITH HOOD

Recessed dual roll toilet paper holder with hood is fabricated of stainless steel. Rollers are made of chrome plated ABS and spring-loaded.

MODEL OPTIONS:
74022 Same as 74022-H but without hood.
7402 Single roll unit.
7402-H Single roll unit with hood.

Overall Dimensions:
 12⅝" x 6⅝"
 (320 x 160 mm)



0263-1
SURFACE MOUNTED SINGLE ROLL TOILET TISSUE DISPENSER

Single roll toilet tissue dispenser with controlled-delivery spindle. Holds and dispenses all standard core roll tissue up to 6" (152 mm) diameter. Fabricated of heavy-duty aluminum casting with satin-matte, silver-grey powder coated finish.

MODEL OPTION:
0264-1 Double roll toilet tissue dispenser.

Overall Dimensions:
 6½" x 1¾" x 4"
 (165 x 45 x 102 mm)



0267
VANDAL-RESISTANT HOOD

14 gauge satin finish stainless steel for use only with 0264-1 (specified and purchased separately).

Unit Size:
 14½" x 7¾" x 6½"
 (359 x 197 x 175 mm)

MODEL OPTION:
0266 Hood for single roll toilet tissue dispenser.

Unit Size:
 7¼" x 7¾" x 6½"
 (184 x 197 x 175 mm)



0697-GAL
SURFACE MOUNTED STAINLESS STEEL SHELF AND DOUBLE TOILET TISSUE HOLDER

Shelf, 18 gauge stainless steel satin finish with front edge hemmed. Holds two 1500 sheet toilet tissue rolls.

Overall Dimensions:
 18" x 4½" x 5"
 (457 x 106 x 127 mm)



7305-B
SURFACE MOUNTED TOILET TISSUE HOLDER

Bright finish stainless steel with chrome plated roller. Heavy gauge concealed bracket mounts on wall. Holds standard core roll.



MODEL OPTIONS:
7305-S Satin finish stainless steel.
7305-2S/2B Holds 2 rolls.

7305-S/B Overall Dimensions:
 7¾" x 2 x 3¾" (207 x 51 x 98 mm)

7305-2S/2B Overall Dimensions:
 13½" x 2 x 3¾" (343 x 51 x 98 mm)

NEW 7305-41 Matte Black.

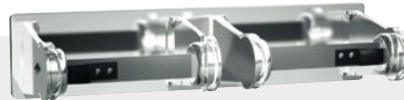

0715
SURFACE MOUNTED DOUBLE TOILET TISSUE HOLDER CHROME PLATED STEEL

Provided with vandal-resistant locking device and mechanism to provide controlled delivery. High polish finish. Dispenses two standard or 1800 sheet toilet tissue rolls.

Overall Dimensions:
 12¾" x 2¾" x 4¼"
 (314 x 70 x 108 mm)

0710
SURFACE MOUNTED SINGLE TOILET TISSUE HOLDER

Overall Dimensions:
 6" x 2¾" x 4¼"
 (152 x 70 x 108 mm)



7403
RECESSED EXTRA ROLL TOILET TISSUE HOLDER

Spring-loaded chrome roller. Extra roll stored behind roll in use.

MODEL OPTIONS:
7403-B Rec., bright stainless steel.
7403-S Rec., satin stainless steel.

NOTE: If drywall installation is required, add suffix "D" to model number. If wetwall installation is required, add suffix "W" to model number (no clamp is required for wetwall).

Overall Dimensions:
 6¾" x 6¼"
 (160 x 159 mm)



**0402-Z
RECESSED SINGLE TOILET TISSUE
HOLDER**

Holds any standard core roll tissue up to 5" (127 mm) diameter. Die-cast of Zamac in seamless one-piece construction.

Wall Opening:
5¼" x 5¼" x 2"
(133 x 133 x 51 mm)



**0477-SM
SURFACE MOUNTED TOILET SEAT
COVER DISPENSER**

Dispenses 250 single or half-fold seat covers. Fabricated of 22 gauge stainless steel with satin finish.

MODEL OPTION:
NEW 0477-SM-41 Matte Black.

Overall Dimensions:
15¾" x 11" x 1¼"
(400 x 279 x 32 mm)

**0477
RECESSED TOILET SEAT COVER
DISPENSER**

Door has tumbler lock, dispenses 500 single or half-fold seat covers.

Unit Size: 17¼" x 12¾" x 2⅝"
(438 x 324 x 60 mm) **Wall Opening:** 15¾" x 11¼" x 2⅝"
(400 x 285 x 67 mm)



**20477-SM
ROVAL™ SURFACE MOUNTED
SEAT COVER DISPENSER**

Dispenses 250 seat covers. Fabricated of 20 gauge stainless steel with a satin finish.

Overall Dimensions:
15¾" x 11" x 2⅝"
(400 x 280 x 60 mm)



**0705-Z
SURFACE MOUNTED TOILET
TISSUE HOLDER**

Fabricated from triple chrome plated rust-resistant Zamac. Dispenses one standard core roll tissue up to 5" (127 mm).

Overall Dimensions:
5⅞" x 1⅞" x 2¾"
(149 x 37 x 70 mm)



**7303
EXTRA ROLL TOILET TISSUE
HOLDER**

Extra roll of toilet tissue is placed over the horn type holder. Stainless steel set screw on bottom of flange locks unit to mounting plate.



**110-13
RECESSED TOILET TISSUE HOLDER –
FRONT MOUNT, SQUARE**

Fabricated of 14 gauge type 304 stainless steel with satin finish exterior, glass blasted satin finish interior 4½" (114 mm) deep accommodates one standard toilet tissue roll. Flange is 7" (179 mm) square. Includes front mounting holes.

Additional security toilet tissue holders are available at americanspecialties.com.



Grab Bars

All ASI grab bars are made in compliance with ADA guidelines for strength requirements. Various configurations are available in satin finish 18 gauge type 304 stainless steel (peened or smooth), powder coated matte black or white, and antimicrobial finishes. These single structure units are heliarc welded, and mandrel bending ensures uniform bar diameters.

SHOWN: 3801-24AW ANTIMICROBIAL GRAB BAR, 3701-24 STAINLESS STEEL GRAB BAR, AND 3801-24-41 GRAB BAR IN MATTE BLACK



EXPOSED MOUNTING

3400 Series — 1¼" (32 mm) O.D.
3500 Series — 1½" (38 mm) O.D.

Features include flange of 3" (76 mm) diameter, ⅝" (3 mm) thick type 304 stainless steel with a satin finish; exposed mounting screw holes are drilled and countersunk.



SNAP FLANGE

3700 Series — 1¼" (32 mm) O.D.
3800 Series — 1½" (38 mm) O.D.

Features include cover that snaps over mounting flange dimples to conceal screws and concealed mounting flange of 3⅝" (79 mm) O.D. diameter with 2 screw holes and 3 locking dimples; ⅝" (3 mm) thick, type 304 stainless steel. Cover is type 304 stainless steel with a satin finish and 22 gauge, 3⅞" (81 mm) diameter.

MODEL OPTIONS:

3700-W White.
3800-W White.
NEW 3800-41 Matte Black.
NEW 3801-18-41 18" Matte Black.
NEW 3801-24-41 24" Matte Black.
NEW 3801-36-41 36" Matte Black.
NEW 3801-42-41 42" Matte Black.



Ag+

GERM GUARD™
POWDER COATING

ANTIMICROBIAL GRAB BAR WITH SNAP FLANGE

3800-AW Series — 1½" (38 mm) O.D.

ASI's Germ Guard™ grab bars are designed to suppress the growth of mold, bacteria, fungus, algae, mildew, and yeasts. They are made from stainless steel and are finished with an electrostatically applied powder coating. This powder coating is custom formulated to incorporate slow release silver ions (Ag+), the most powerful and long-lasting natural antimicrobial agent known.

3801-18AW 18"
3801-24AW 24"
3801-36AW 36"

3801-42AW 42"
3801-48AW 48"

GRAB BAR CONFIGURATIONS

The following standard shapes are typical configurations. Grab bars can be custom designed and manufactured to meet any specific architectural requirement.

Designers Note:

For a non-slip surface, specify suffix "P" (peened). When specifying grab bars insert the configuration type numbers listed below into the double zeros at the end of the grab bar series number.

Example 1: A 1½" (38 mm) concealed 18" x 33" (460 x 840 mm) horizontal grab bar has a model number—3874. When a special size is needed, add suffix "M" plus the size, to the closest standard bars.

Example 2: A 1½" (38 mm) concealed 23" x 37" (585 x 940 mm) horizontal grab bar has a model number 3874-M2337.

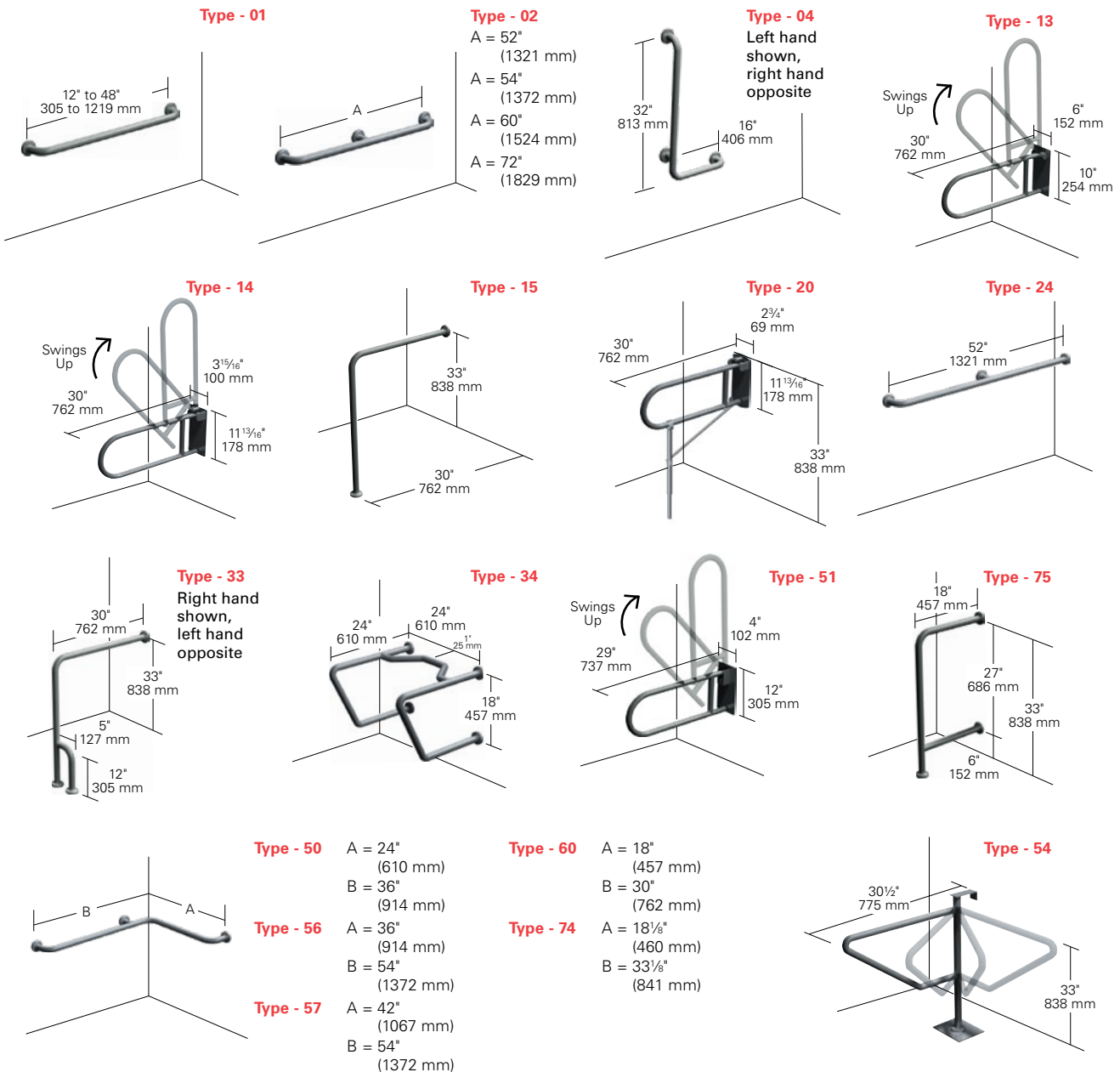



Shower/Tub Accessories

ASI provides a full range of shower and tub accessories that show attention to details to address the safety and comfort needs of users. All items—including shower seats and benches, tub seats, soap dishes, and shower curtain rods—are designed to ensure secure installation and easy use.

SHOWN: 1201-A CURVED SHOWER CURTAIN ROD WITH MOUNTING BRACKETS



0398
RECESSED HEAVY-DUTY SOAP DISH AND BAR

Stainless steel unit with bright polished finish exterior and sand blasted finish interior. Includes mounting clamp for stud walls.

Overall Dimensions:
 7¹/₈" x 5" x 4"
 (181 x 127 x 102 mm)

Wall Opening:
 6¹/₈" x 4¹/₈" x 4"
 (156 x 105 x 102 mm)

MODEL OPTIONS:

0399 Same as 0398, but includes kit for installing in cement wall.

0400 Without bar.

0401 Same as 0400, but includes kit for installing in cement wall.



0410-Z
RECESSED SOAP DISH WITH BAR

Die-cast of Zamac in seamless one-piece construction. A plastic soap tray with drying ribs interlocks with housing for retention.

Overall Dimensions:
 6¹/₄" x 6¹/₄" x 3³/₈"
 (181 x 127 x 86 mm)

Wall Opening:
 5¹/₄" x 5¹/₄" x 2"
 (133 x 133 x 51 mm)



7404-S
RECESSED SOAP DISH

Seamless one-piece construction fabricated of 22 gauge stainless steel with satin finish. Provided with a raised lip to retain soap.

MODEL OPTION:
7404-B Bright stainless steel.

Overall Dimensions: 6¼" x 6⅝" x 2" (159 x 160 x 51 mm)	Wall Opening: 5½" x 5½" x 2" (140 x 140 x 51 mm)
---	---



7410-B
RECESSED SOAP DISH AND BAR

One-piece construction soap dish fabricated of 22 gauge stainless steel with bright finish. Includes a bar, held permanently between two posts at top of unit.

MODEL OPTION:
7410-S Satin stainless steel.

Overall Dimensions: 6⅝" x 6¼" x 3" (160 x 159 x 76 mm)	Wall Opening: 5½" x 5½" x 2" (140 x 140 x 51 mm)
---	---



1204
EXTRA HEAVY-DUTY SHOWER CURTAIN ROD

3⅜" (81 mm) diameter flanges of 20 gauge type 304 stainless steel with satin finish and 1¼" (32 mm) diameter rod of 18 gauge type 304 stainless steel tubing with satin finish. Available in lengths up to 96" (2438 mm); special order on longer lengths.

MODEL OPTION:
1214 20 gauge, 1" (25 mm) diameter rod. Available in lengths up to 72" (1829 mm).



1201-A
CURVED SHOWER CURTAIN ROD WITH MOUNTING BRACKETS

Fabricated of type 304 stainless steel. Tubing is 18 gauge, 1" DIA (25 mm) with a satin finish. Length is suitable for a 60" (1524 mm) wide enclosure either on opposite walls (-B) or across the face opening (-A) depending upon rod length chosen.

MODEL OPTION:
1201-B Curved shower curtain rod with mounting brackets for opposite walls.

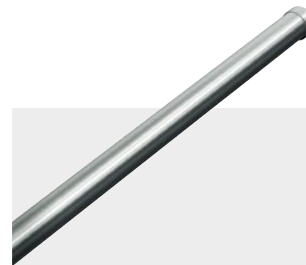

1224
CONCEALED MOUNTING SHOWER CURTAIN ROD

Chrome plated brass with satin finish flanges and 1" (25 mm) diameter rod of 20 gauge type 304 stainless steel with satin finish. One flange has set screw to lock rod and prevent rotation. Available in lengths up to 72" (1829 mm); for longer lengths, specify 1204.



**1200-SHU
SHOWER CURTAIN HOOK**

Stainless steel hook for rods 1" (25 mm) and 1¼" (32 mm) diameter.

Overall Dimensions:

1⅝" x 2⅞"
(40 x 67 mm)



**1200-V
VINYL SHOWER CURTAIN**

Flame-resistant, anti-bacterial, 10 gauge white vinyl fabric with standard height of 72" (1829 mm). Curtain should be 6" (152 mm) wider than opening up to 42" (1067 mm) and 12" (305 mm) wider than opening exceeding 42" (1067 mm).



**8203
COMPACT FOLDING SEAT**

⅝" (8 mm) thick, one-piece, solid, white colored, black core phenolic seat. Frame, support legs, flanges, and bracket are satin finish stainless steel. Features a self-locking mechanism. Meets ADA Accessibility Guidelines and the needs of the physically disabled and elderly when properly installed. Seat measures 18" (457 mm) wide and projects 16" (406 mm) from wall. Additional width options are available in 20", 28", and 33" (order with suffix -20, -28, and -33).

MODEL OPTIONS:

8204 Seat is sponge cushion covered with off-white Naugahyde® mounted on ½" (13 mm) thick marine grade plywood.
8207 Seat is fabricated of stainless steel, satin finish, slatted design.



**8208-R
FOLDING SHOWER SEAT**

(Right hand) Slats are fabricated with stainless steel in satin finish. Requires only one hand operation to manually lower to horizontal position for use or raise for departure and arrival. Guide bracket with spring detent prevents seat from dropping and provides positive support in usage position as well as spring locked storage position. Meets ADA Accessibility Guidelines and the needs of the physically disabled and elderly when properly installed. Seat measures 33" (838 mm) wide and projects 23" (584 mm) from wall.

MODEL OPTION:

8208-L Left hand seat.



**0010
CORNER SHOWER SEAT**

Seat, support brackets, and retainer clip are satin finish stainless steel. Seat is secured to one wall with full length piano hinge and support on other wall by bracket. Meets ADA Accessibility Guidelines and the needs of the physically disabled and elderly when properly installed.

Overall Dimensions:

15¾" x 15¾"
(400 x 400 mm)



**8358
FOLDING TUB SEAT**

½" (13 mm) thick, solid, white colored, black core phenolic seat. Frame, mounting bracket, and retainer hook are satin finish stainless steel. Meets ADA Accessibility Guidelines and the needs of the physically disabled and elderly when properly installed. Seat measures 15" (387 mm) wide and projects 33¾" (860 mm) from wall.



8206-L
FOLDING SHOWER SEAT

(Left hand) Meets ADA Accessibility Guidelines and the needs of the physically disabled and elderly when properly installed. Seat is 1/2" (13 mm) thick, one-piece, solid, white colored, black core phenolic. Frame, support legs, flanges, and bracket are satin finish stainless steel. Phenolic seat ONLY is field reversible. Seat measures 33" (838 mm) wide and projects 22 7/8" (581 mm) from wall.

MODEL OPTIONS:

8206-R Right hand seat.

8205-L Left hand seat with cushion covered in off-white Naugahyde.

8205-R Right hand seat with cushion covered in off-white Naugahyde.



NEW

8206-SC-L
SLOW CLOSE FOLDING SHOWER SEAT

Slow Close Phenolic L-Shaped Fold Up Shower Seat provides added safety and ease of use. Gas charged struts assist one-handed opening by allowing the slowly lowering seat to its operating position and also assists in partial closing. (Left hand) Meets ADA Accessibility Guidelines and the needs of the physically disabled and elderly when properly installed. Seat is 1/2" (13 mm) thick, one-piece, solid, white colored, black core phenolic. Frame, support legs, flanges, and bracket are satin finish stainless steel. Phenolic seat ONLY is field reversible. Seat measures 33" (838 mm) wide and projects 22 7/8" (581 mm) from wall.

MODEL OPTION:

8206-SC-R Right hand seat.



8209
RECTANGULAR PHENOLIC FOUR-LEG FOLD-UP SHOWER BENCH

Seat is 1/2" (13 mm) thick solid phenolic, with white top and bottom surfaces, and black edges. Frame, mounting bracket, and retainer hook are satin finish stainless steel. Meets ADA Accessibility Guidelines and the needs of the physically disabled and elderly when properly installed. Seat is 22 1/2" (572 mm) deep and 48" (1219 mm) wide, projecting 24" (610 mm) from the wall when in the open position. When retracted, legs fold up to provide low profile against wall.



8202
L-SHAPED PHENOLIC FOUR-LEG FOLD-UP SHOWER SEAT

Seat is 1/2" (13 mm) thick solid phenolic, with white top and bottom surfaces, and black edges, and is field reversible for left or right hand. Rear load feet remain on floor with rear frame mounted to wall and never need adjustment after correct installation. Front legs fold up automatically when seat is raised. Gravity prevents seat from dropping. Seat measures 33 1/2" (851 mm) wide and projects 15 1/2" (395 mm) from wall. Meets ADA Accessibility Guidelines and the needs of the physically disabled and elderly when properly installed.

SHOWN: 9013 BABY CHANGING STATION



BABY CHANGING STATIONS

ASI offers baby safe solutions for baby changing stations. All units are easy to install, durable, and sanitary. To meet your washroom needs, we offer numerous choices along with many ADA-compliant models.

WHAT MAKES OUR BABY CHANGING STATIONS UNIQUE?

UPTO
50
LB. CAPACITY

LARGE WEIGHT CAPACITY

Our baby changing stations have been tested using ASTM F2285-04 and EN 12221-1 protocol for a static load and in addition have been tested to hold a weight up to 250 lbs [113kg].



ADA ACCESSIBILITY STANDARD COMPLIANT

Our units are engineered to comply with the standards set forth by the American Disabilities Act for accessibility and safety.

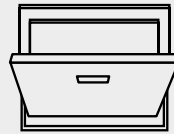

EASY OPEN AND CLOSE

Our units are designed for easy one-handed operation and shaped to safely cradle a child's body.

FDA
APPROVED

FUNGUS- AND BACTERIA-RESISTANT PLASTIC

Our baby changing stations are made with FDA-approved fungus- and bacteria-resistant plastic.

FEATURES

- Easy to install
- Sanitary, safe, and strong

- All units fold up; no obstruction when not in use
- Easy to clean



SOAP DISPENSERS

See our Soap Dispensers on pages 60-67.



SANITIZING (NO) TOUCH ACCESSORIES

See our Sanitizing (NO) Touch Accessories on pages 64-66.



9014
SURFACE MOUNTED HORIZONTAL PLASTIC BABY CHANGING STATION

Fabricated of FDA-approved fungus and bacteria-resistant plastic. Intended use for infants up to 3.5 years old and up to 50 lbs (23kg). Its vinyl-coated, adjustable safety strap assures child protection.

Overall Dimensions:

Closed:	Open:
35 ⁵ / ₃₂ " x 24 ¹ / ₄ " x 3 ⁷ / ₈ "	35 ⁵ / ₃₂ " x 24 ¹ / ₄ " x 22 ¹ / ₃₂ "
(893 x 616 x 98 mm)	(893 x 616 x 560 mm)



9014-41
BABY CHANGING STATION, HORIZONTAL – MATTE BLACK, SURFACE MOUNTED

This horizontal unit has a pull handle and concealed damped gas spring, assisting in easy operation. Fabricated of FDA-approved fungus- and bacteria-resistant plastic. Intended use for infants up to 3.5 years old and up to 50 lbs (23kg). Its vinyl-coated, adjustable safety strap assures child protection.

Overall Dimensions:

Closed:	Open:
35 ⁵ / ₃₂ " x 24 ¹ / ₄ " x 3 ⁷ / ₈ "	35 ⁵ / ₃₂ " x 24 ¹ / ₄ " x 22 ¹ / ₃₂ "
(893 x 616 x 98 mm)	(893 x 616 x 560 mm)



9013
RECESSED STAINLESS STEEL BABY CHANGING STATION

ADA-compliant unit features welded stainless steel for long and reliable use. Exposed surfaces are satin finish. Easy one-handed operation is assisted by a pull handle and concealed spring. The changing surface is high-impact-resistant plastic for easy cleaning. Featuring a two-part adjustable safety strap, intended use for infants up to 3.5 years old and a load capacity of up to 50 lbs (23 kg), this product ensures child protection.

MODEL OPTION:

9013-9 Surface mounted with a stainless steel collar.

Overall Dimensions:

Open:	Closed:
37" x 25 ¹ / ₂ " x 17 ³ / ₄ "	37" x 25 ¹ / ₂ " x 3 ⁷ / ₈ "
(940 x 648 x 451 mm)	(940 x 648 x 10 mm)

Wall Opening:

34¹/₂" x 22³/₄" x 3³/₄" min (870 x 578 x 95 mm)



9012
SURFACE MOUNTED PLASTIC BABY CHANGING STATION

Modern styling and easy-to-clean surface is fabricated of 100% high-density polyethylene. Intended use for infants up to 3.5 years old and up to 50 lbs (23kg). Surface mounted. Only 4" (102 mm) deep when closed.

Overall Dimensions:

Closed:	Open:
36" x 22" x 4"	36" x 22" x 20 ⁷ / ₁₆ "
(914 x 559 x 102 mm)	(914 x 559 x 519 mm)



9015
SURFACE MOUNTED VERTICAL PLASTIC BABY CHANGING STATION

Vertical unit has a pull handle and concealed damped gas spring, assisting in easy operation. Can be fabricated of FDA-approved fungus and bacteria-resistant plastic. Intended use for infants up to 3.5 years old and up to 50 lbs (23kg). Its vinyl-coated, adjustable safety strap assures child protection.

Overall Dimensions:

Closed:	Open:
24¼" x 35½" x 3⅞"	24¼" x 35½" x 32⅛"
(616 x 893 x 98 mm)	(616 x 893 x 837 mm)



9020
SURFACE MOUNTED TODDLER SAFETY SEAT

This plastic seat, mounted on the inside of the toilet partition, either on the door or panel, allows a parent to take a toddler into the stall with them. Unit shall support a static load of 50 lbs. (23 kg). Fabricated of FDA approved plastic.

Overall Dimensions:

Closed:	Open:
12½" x 21¾" x 5½"	12½" x 21¾" x 11⅞"
(318 x 552 x 140 mm)	(318 x 552 x 283 mm)



9017
RECESSED VERTICAL STAINLESS STEEL BABY CHANGING STATION

This vertical station has a door facing and collar made from 18 gauge 304 stainless steel. Fabricated of FDA-approved fungus and bacteria-resistant plastic. Intended use for infants up to 3.5 years old and up to 50 lbs (23kg).

Overall Dimensions:

Closed:	Open:
28¼" x 39½" x ⅝"	28¼" x 39½" x 29⅞"
(718 x 994 x 10 mm)	(718 x 994 x 746 mm)

Wall Opening:

24½" x 35½" x 4" min (622 x 902 x 102 mm)



9017-9
SURFACE MOUNTED VERTICAL STAINLESS STEEL BABY CHANGING STATION

This vertical station has a door facing and collar made from 18 gauge 304 stainless steel. Fabricated of FDA-approved fungus and bacteria-resistant plastic. Intended use for infants up to 3.5 years old and up to 50 lbs (23kg).

Overall Dimensions:

Closed:	Open:
28¼" x 39½" x 3⅞"	28¼" x 39½" x 32⅞"
(718 x 995 x 100 mm)	(718 x 995 x 822 mm)

Wall Opening:

24½" x 35½" x 4" min (622 x 902 x 102 mm)



9018

RECESSED HORIZONTAL STAINLESS STEEL BABY CHANGING STATION

This horizontal station has a door facing and collar made from 18 gauge 304 stainless steel. Fabricated of FDA-approved fungus and bacteria-resistant plastic. Unit complies with 2010 ADA Accessibility Standards. Intended use for infants up to 3.5 years old and up to 50 lbs (23kg).

Overall Dimensions:

Closed:	Open:
39 ⁵ / ₃₂ " x 28 ¹ / ₄ " x 3 ⁵ / ₁₆ "	39 ⁵ / ₃₂ " x 28 ¹ / ₄ " x 18 ¹ / ₈ "
(995 x 718 x 10 mm)	(995 x 718 x 460 mm)

Wall Opening:

35¹/₂" x 24¹/₂" x 4" min (902 x 622 x 102 mm)



9018-9

SURFACE MOUNTED HORIZONTAL STAINLESS STEEL BABY CHANGING STATION

This horizontal station has a door facing and collar made from 18 gauge 304 stainless steel. Fabricated of FDA-approved fungus and bacteria-resistant plastic. Unit complies with 2010 ADA Accessibility Standards. Intended use for infants up to 3.5 years old and up to 50 lbs (23kg).

Overall Dimensions:

Closed:	Open:
39 ⁵ / ₃₂ " x 28 ¹ / ₄ " x 3 ⁵ / ₁₆ "	39 ⁵ / ₃₂ " x 28 ¹ / ₄ " x 18 ¹ / ₈ "
(995 x 718 x 84 mm)	(995 x 718 x 460 mm)



9018-41
BABY CHANGING STATION, HORIZONTAL –
MATTE BLACK, RECESSED

This horizontal unit has a pull handle and concealed damped gas spring, assisting in easy operation. Fabricated of FDA-approved fungus- and bacteria-resistant plastic. Intended use for infants up to 3.5 years old and up to 50 lbs (23kg). Its vinyl-coated, adjustable safety strap assures child protection.

Overall Dimensions:

Closed:	Open:
35 ⁹ / ₃₂ " x 24 ¹ / ₄ " x 3 ⁷ / ₁₆ "	35 ⁹ / ₃₂ " x 24 ¹ / ₄ " x 22 ¹ / ₃₂ "
(893 x 616 x 98 mm)	(893 x 616 x 560 mm)



9018-9-41
BABY CHANGING STATION, HORIZONTAL –
MATTE BLACK, STAINLESS STEEL, SURFACE MOUNTED

This horizontal station has a door facing and collar made from 20 gauge 304 stainless steel with a powder coated matte black finish. Fabricated of FDA-approved fungus and bacteria-resistant plastic. Unit complies with 2010 ADA Accessibility Standards. Intended use for infants up to 3.5 years old and up to 50 lbs (23kg).

Overall Dimensions:

Closed:	Open:
39 ⁹ / ₃₂ " x 28 ¹ / ₄ " x 3 ⁷ / ₁₆ "	39 ⁹ / ₃₂ " x 28 ¹ / ₄ " x 18 ¹ / ₈ "
(995 x 718 x 10 mm)	(995 x 718 x 460 mm)



Shelves

ASI offers various configurations, sizes, and styles, including platform, recessed, and folding utility shelving—all sturdy, durable, and constructed of stainless steel.

SHOWN: 20692 SURFACE MOUNTED SHELF



0690
SHELF WITH RAISED EDGES

Entire unit is formed of one piece of 18 gauge stainless steel having a $\frac{3}{16}$ " (10 mm) depression with a satin finish.

See chart for standard sizes.

	Model Numbers			
	0690	0692	0694	20692
Standard Sizes:	6" depth (152 mm)	5", 6" or 8" depth (127,152, 203 mm)	5" depth (127 mm)	6" depth (152 mm)
Length				
12" (305 mm)		■		■
16" (406 mm)		■		
18" (457 mm)	■	■	■	■
24" (610 mm)	■	■	■	■
30" (762 mm)		■		■
36" (914 mm)		■		■
48" (1219 mm)		■	■	■
60" (1524 mm)		■	■	■
72" (1829 mm)				■



0692
SURFACE MOUNTED SHELF

Fabricated of 18 gauge stainless steel with a satin finish. Front edge is hemmed for maximum rigidity and safety.

See chart for standard sizes.



0698
FOLDING UTILITY SHELF FOR TOILET COMPARTMENTS

Fabricated of 18 gauge satin finish stainless steel with raised rim. Shelf automatically returns to upright position when not in use.

Overall Dimensions:
14⁵/₈" x 5¹³/₁₆"
(371 x 148 mm)



0412
RECESSED SHELF

This unit is fabricated of 22 gauge, all welded construction, stainless steel with a satin finish.

Overall Dimensions:
18" x 8" x 4¹/₄" min
(457 x 203 x 108 mm)

Wall Opening:
16¹/₂" x 6¹/₂" x 4" min
(419 x 165 x 102 mm)



0694
SURFACE MOUNTED SHELF WITH BACKSPLASH

Fabricated of 18 gauge stainless steel with a satin finish on exposed surfaces with 5" (127 mm) depth.



20692
ROVAL™ SURFACE MOUNTED SHELF

Fabricated of 18 gauge stainless steel, the 6" wide shelf has a ³/₄" (19 mm) gently radiused edge. Choice of sizes.

Overall Dimensions:
6" x 12"-72"
(152 x 305-1829 mm)

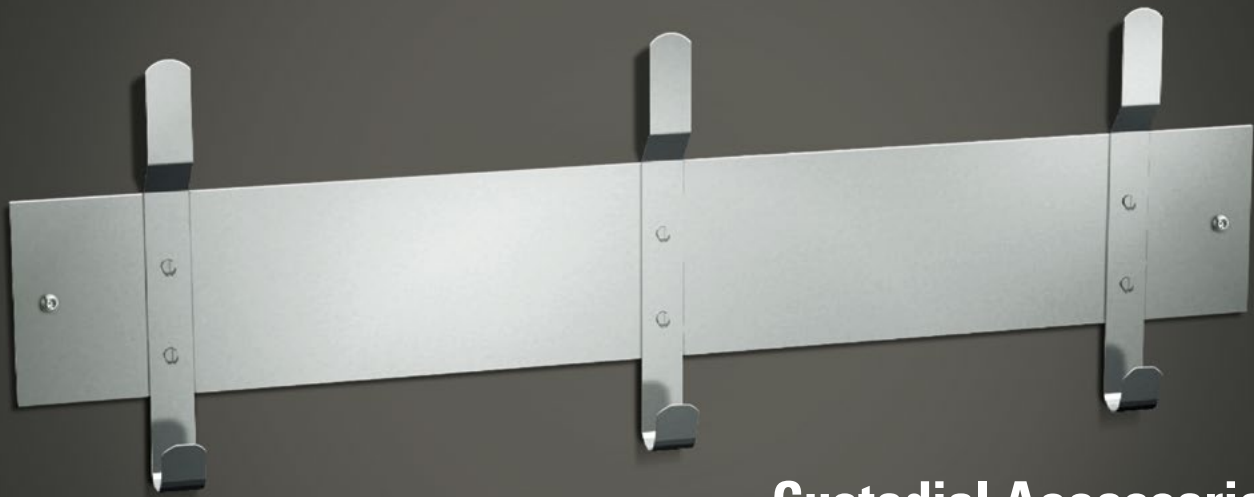

Custodial Accessories

Fabricated of type 304 satin finish stainless steel, our one-piece constructed custodial accessories—with various configurations of mop and broom holders and utility hooks—help keep necessary cleaning tools and supplies organized and accessible.

SHOWN: 1307-3 UTILITY HOOK STRIP WITH 3 HOOKS 26" (660 mm)



1307-3
UTILITY HOOK STRIP WITH 3 HOOKS

Fabricated of stainless steel with satin finish, this strip is 4" (102 mm) high with edges returning ½" (13 mm) to the wall. Measures 26" (660 mm) long.

MODEL OPTIONS:

1307-4 With 4 hooks 36" (914 mm) long.

1307-5 With 5 hooks 46" (1168 mm) long.

1307-6 With 6 hooks 56" (1422 mm) long.



1308-3
SHELF WITH 4 UTILITY HOOKS AND 3 MOP HOLDERS STRIP

Fabricated of satin finish stainless steel, this shelf is 8" (203 mm) deep with ¾" (19 mm) return for rigidity. Mop holders are riveted to strip, and rubber cam is ribbed for grasping. Unit is 14½" (368 mm) high. Measures 34" (860 mm) long.

MODEL OPTION:

1308-4 4 mop holders/5 utility hooks, 44" (1118 mm) long.



1306
HEAVY-DUTY UTILITY HOOK
 Heavy-duty 14 gauge stainless steel with satin finish.



0533 SERIES
CORNER GUARD
 Surface Mounted Corner Guard is constructed of robust 18 gauge stainless steel and is finished with a 1/8" radius outside edge. Guard can be mounted flush to floor or at base height. Ideal for a variety of applications.

Overall Dimensions:
 48" x 4 1/4" x 4 1/4" (1219 x 108 x 108 mm)

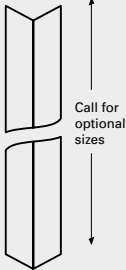

1) CHOOSE EDGE AND MOUNTING STYLE:

- | | |
|----------------------------------|-----------------------------------|
| 0533-1 Beveled w/ Adhesive | 0533-3 Straight w/ Adhesive |
| 0533-2 Beveled w/ Mounting Holes | 0533-4 Straight w/ Mounting Holes |

2) ADD PREFIX FOR GAUGE:

1 (16 Gauge) or 2 (18 Gauge)
 Ex: 0533-3-2 straight edges with adhesive mounting, 18 gauge



8215-5
MOP AND BROOM RACKS
 5 holders, 46" (1168 mm) long. Fabricated from one-piece hi-hat channel stainless steel.

MODEL OPTIONS:
8215-3 3 holders, 26" (660 mm) long.
8215-4 4 holders, 36" (914 mm) long.



1315-4
UTILITY SHELF WITH DRYING ROD, 4 MOP HOLDERS, AND 3 RAG HOOKS

Fabricated of satin finish stainless steel, this shelf is 8" (203 mm) deep with 3/4" (19 mm) return for rigidity. Mop holders are riveted to strip, and rubber cam is ribbed for grasping. Rod and hooks for wet rags are included. Measures 36" (914 mm) long.

MODEL OPTIONS:
1315-3 3 mop holders/2 rag hooks, 30" (762 mm) long.
1315-6 6 mop holders/5 rag hooks, 48" (1219 mm) long.

SHOWN: 0501-4 SURFACE MOUNTED
SURGICAL GLOVE DISPENSER



HEALTHCARE ACCESSORIES

ASI offers many different items that are specifically designed for healthcare settings. All of these items contribute to providing an organized and hygienic environment for patients and caregivers. From innovative products like new antimicrobial

grab bars and a slow close shower seat, to glove dispensers, security cabinets, and hazardous waste disposals—ASI healthcare accessories are designed for ease of use, safety, durability, and peace of mind.

WHAT MAKES OUR HEALTHCARE ACCESSORIES UNIQUE?

18-22
GAUGE

STAINLESS STEEL CONSTRUCTION

Our cabinets are made of stainless steel, which is tough, durable, stain-resistant and easy to clean.

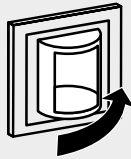

CYLINDER LOCK

The design of our cylinder locks allows for the removal of the cylinder for sterilizing or autoclaving when necessary.

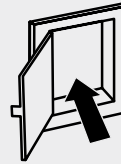

CONVENIENT PASSAGE

Our specimen pass box and cabinet enables easy access and safe handling of specimens from patient area to laboratory.



ADJUSTABLE SHELVES

The design of our cabinets offers flexibility with adjustable shelves for ease in storage and use.



NEW
8206-SC
SLOW-CLOSE
SHOWER
SEAT



8203
COMPACT
FOLDING
SEAT

See our Shower Seat Collection, pages 90-91.



8202
SHOWER
SEAT



8208
SHOWER
SEAT



0952

RECESSED STAINLESS STEEL MEDICINE CABINET

Swing door mirror frame is stainless steel with satin finish. Mirror is 1/4" (6 mm), guaranteed for 15 years against silver spoilage. Door has full length piano hinge and magnetic catch. Three removable stainless steel shelves.

Overall Dimensions:

18 1/4" x 24 1/4" x 4 1/2"
(464 x 616 x 114 mm)

Wall Opening:

16" x 22 3/4" x 3 1/2"
(406 x 578 x 89 mm)

MODEL OPTION:

0952-B Larger than 0952.

Overall Dimensions:

24" x 26" x 4 7/8"
(610 x 660 x 124 mm)

Wall Opening:

21 3/4" x 24 1/2" x 3 1/2"
(550 x 620 x 89 mm)



0953

SURFACE MOUNTED STAINLESS STEEL MEDICINE CABINET

Surface mounted cabinet is made from 20 gauge stainless steel with a satin finish. Mirrored door is hung on cabinet with a full length 3/8" staked piano hinge. Cabinet has three adjustable stainless steel shelves.

Overall Dimensions:

18 1/4" x 24 1/4" x 4 3/4"
(464 x 616 x 121 mm)



0533 SERIES

CORNER GUARD

Surface Mounted Corner Guard is constructed of robust 18 gauge stainless steel and is finished with a 1/8" radius outside edge. Guard can be mounted flush to floor or at base height. Ideal for a variety of applications.

Overall Dimensions:

48" x 4 1/4" x 4 1/4" (1219 x 108 x 108 mm)

1) CHOOSE EDGE AND MOUNTING STYLE:

0533-1 Beveled w/ Adhesive	0533-3 Straight w/ Adhesive
0533-2 Beveled w/ Mounting Holes	0533-4 Straight w/ Mounting Holes

2) ADD PREFIX FOR GAUGE:

1 (16 Gauge) or 2 (18 Gauge)

Ex: 0533-3-2 straight edges with adhesive mounting, 18 gauge

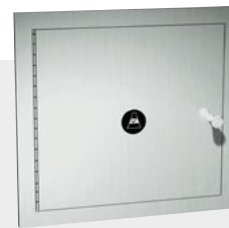

8154

RECESSED PASS-THROUGH SPECIMEN CABINET

Provides a convenient passage from patient area into laboratory. Fabricated of 18 gauge satin finish stainless steel. Internal latch prevents simultaneous door opening. Stainless steel tray is removable. Mounts in wall thickness of 1 3/4" to 5 1/2" (44 to 140 mm).

MODEL OPTIONS:

8155 Extension sleeve and flange for recessed specimen pass-through cabinet.

8156 Same as 8154 including 8155 extension sleeve.



8340

RECESSED POWDER COATED MEDICINE CABINET

One-piece, drawn cold rolled steel with white powder coated steel finish. Stainless steel channel framed mirrored door with 1/4" (6 mm) thick plate glass, has continuous piano hinge and magnetic catch. Three removable white enamel steel shelves.

Overall Dimensions:

18 1/4" x 24 1/4" x 4 1/8"
(465 x 615 x 120 mm)

Wall Opening:

16" x 22 3/4" x 3 1/2"
(406 x 578 x 89 mm)

MODEL OPTIONS:

8338 Smaller and has two adjustable white baked enamel steel shelves.

14 1/8" x 20 3/16" x 5"
(359 x 513 x 125 mm)

8339 Larger than 8338.

16 3/16" x 22 3/16" x 5"
(411 x 564 x 127 mm)



0515

TURNTABLE SPECIMEN PASS BOX

Fabricated of 18 gauge satin finish stainless steel. Turntable cylinder is 12" (305 mm) diameter with 10 1/2" x 6" (267 x 152 mm) opening. Stainless steel self-lubricating ball bearing plates mounted on top and bottom permit the unit to rotate freely. Positioned bullet catches prevent uncontrolled rotation. Entire inner assembly is encased in 1" (25 mm) wide trim. Cylinder lock allows for the removal of the cylinder for sterilizing or autoclaving when necessary. Trim is adjustable for wall up to 7" (178 mm) thick.



0350

SURGICAL SOAP DISPENSER

Dispenses liquid antiseptic solutions and synthetic detergent soaps. Chrome plated brass body. Capacity: 16 oz. (0.5 L) white polyethylene globe.

Overall Dimensions:

3 3/8" x 6 1/2" x 5 1/8"
(86 x 165 x 130 mm)



0349

FOOT OPERATED SURGICAL SOAP DISPENSER

Pneumatic pump mechanism, 32 oz. (0.9 L) polyethylene container. Free turning spout is type 316 stainless steel. 96" (2438 mm) long vinyl tubing attaches to anti-slip foot pump. Dispenses liquid surgical soaps, antiseptic solutions, and synthetic detergents.

Overall Dimensions:

4 1/4" x 12 3/4" x 9"
(108 x 324 x 229 mm)

Spout Projection: 9" (229 mm) from wall



0815
FLOOR STANDING FOOT OPERATED WASTE RECEPTACLE

Foot operated waste receptacle with satin finish stainless steel body and top. Connected with multi-staked piano hinge and features hemmed edges for safety.
 Capacity: 8 gal. (30.7 L).

Overall Dimensions:
 10³/₄" x 20¹⁵/₁₆" x 10"
 (273 x 531 x 254 mm)



ANTIMICROBIAL GRAB BAR WITH SNAP FLANGE
3800-AW Series — 1¹/₂" (38 mm) O.D.

ASI's Germ Guard™ grab bars are designed to suppress the growth of mold, bacteria, fungus, algae, mildew, and yeasts. They are made from stainless steel and are finished with an electrostatically applied powder coating. This powder coating is custom formulated to incorporate slow release silver ions (Ag+), the most powerful and long-lasting natural antimicrobial agent known.

MODEL OPTIONS:
3801-18AW 18" **3801-42AW** 42"
3801-24AW 24" **3801-48AW** 48"
3801-36AW 36"



NEW
0503
HANDS-FREE ARM GRIP DOOR PULL

Hands-free arm grip door pull provides an alternative to open doors without having to use hands. Grip is surface mounted with self-threading flat head screws (by others) through holes provided, at standard mid-door height, or no higher than 40" above finished floor for ADA compliance, to allow placing the forearm to pull door open. Constructed of 11 gauge stainless steel with satin finish and fully deburred edges for user safety.

Overall Dimensions:
 1³/₄" x 2¹/₈" x 3"
 (44 x 54 x 76 mm)



NEW
0504
HANDS-FREE FOOT GRIP DOOR PULL

Hands-free foot grip door pull provides an alternative to open doors without having to use hands. Grip is surface mounted with self-threading flat head screws (by others) through holes provided, at base of door aligned with bottom edge or slightly above, and as close to opening side as possible. Constructed of 11 gauge stainless steel with satin finish and fully deburred edges for user safety.

Overall Dimensions:
 3" x 3" x 2⁹/₁₆"
 (76 x 76 x 54 mm)

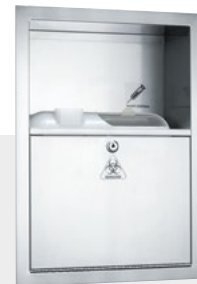

0548
RECESSED SHARPS DISPOSAL CABINET

Satin finish stainless steel. Marked with graphic label indicating Biohazard. Holds one Becton, Dickinson and Company (BD) brand Sharps Collector model #305443 (not included).

Overall Dimensions: **Wall Opening:**
 13³/₄" x 19¹/₁₆" x 5¹/₄" 12¹/₈" x 17³/₄" x 5"
 (349 x 486 x 133 mm) (308 x 451 x 127 mm)

MODEL OPTION:
0548-9 Surface mounted with a stainless steel collar.



0501-X
SURFACE MOUNTED SURGICAL
GLOVE DISPENSER

Satin finish stainless steel holds and dispenses gloves from one standard surgical glove box. Fully hemmed-in rolled edges for snag-free dispensing and user safety.

MODEL OPTIONS:

- 0501-1** Dispenser for 1 box.
- 0501-2** Dispenser for 2 boxes.
- 0501-3** Dispenser for 3 boxes.
- 0501-4** Dispenser for 4 boxes.



0511
SURFACE MOUNTED BULK
DISPENSER, SMALL

Satin finish stainless steel. Dispenses various personal protection equipment such as gloves, caps, and shoe covers (not supplied).

Overall Dimensions:
 12⁵/₆₄" x 11" x 5¹/₂"
 (307 x 279 x 140 mm)

MODEL OPTION:
0512 Large bulk dispenser.

Overall Dimensions:
 12⁵/₆₄" x 17" x 5¹/₂"
 (307 x 431 x 140 mm)



0551
RECESSED BEDPAN AND URINAL
BOTTLE CABINET

Recessed cabinet is 22 gauge satin finish stainless steel for storage of bedpan and urinal. Cabinet provided with 1/2" (13 mm) open space across top and bottom of door to allow air circulation.

Overall Dimensions:
 15" x 28" x 5¹/₄"
 (381 x 711 x 133 mm)

Wall Opening:
 13³/₈" x 26¹/₂" x 5³/₈"
 (340 x 670 x 140 mm)

MODEL OPTION:
0558-1 Recessed bedpan and wash basin cabinet.



0557
SURFACE MOUNTED BEDPAN RACK

Surface mounted rack provides convenient storage for one conventional sized bedpan.

Overall Dimensions:
 12" x 11" x 4⁷/₈"
 (305 x 279 x 124 mm)

MODEL OPTIONS:

- 0556** Surface mounted bedpan and urinal rack.
- 0559** Surface mounted double bedpan rack. Similar to 0556, but designed to hold two conventional sized bedpans.



0198-MH
SAFE-DRI™ MENTAL HEALTH
APPROVED RECESSED HIGH-SPEED
HAND DRYER

Anti-ligature dryer designed for Behavioral Health environments—angled top, welded corners, and single tube exhaust prevent looping, tying off, wedging, and prying. Tamper-resistant 18 gauge stainless steel cover and flush pin-hex security screws. Available in 115-120 V and 208-240 V.

Unit Size:
 12⁵/₈" x 15³/₄" x 5¹/₁₆"
 (320 x 400 x 140 mm)

Wall Opening:
 12¹/₄" x 15¹/₁₆" x 5¹/₄"
 (311 x 386 x 133 mm)

Decibel Level:
 66 dB-A @ 2M



SHOWN: 7383 TOWEL SHELF WITH HANGER ROD



HOSPITALITY ACCESSORIES

ASI offers a wide range of options to accessorize the washroom setting. These items include towel bars and racks, clothes hooks, shelving and holders. All items are easy to install and easy to clean. These items add a special touch and convenience for washroom users.

WHAT MAKES OUR HOSPITALITY ACCESSORIES UNIQUE?

304

STAINLESS STEEL

STAINLESS STEEL CONSTRUCTION

Our heavy-duty items are made of high-quality type 304 stainless steel, which is tough, durable, stain-resistant, and easy to clean.

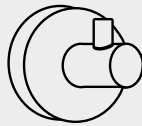

MINIMALISTIC, CONTEMPORARY, AND CLASSIC

Different styles allow you to choose what works best to complement your washroom.

LEED®

FRIENDLY

LEED®-FRIENDLY

The robust construction made of type 304 stainless steel is LEED®-friendly and fits our sensibility about longer lifecycle building designs.



REFINED LOOK, RICH FUNCTION

These accessories add a special touch to enhance the user's experience in the washroom setting.

FEATURES

- Easy to install
- Hygienic and safe to use
- Durable
- Easy to clean



FRAMELESS MIRRORS



STAINLESS STEEL MIRRORS



FRAMELESS MIRRORS WITH LED BACKLIGHT

See our mirrors on pages 67-71.



7308

SINGLE ROBE HOOK

Extends 2 $\frac{3}{8}$ " (59 mm) from wall or door. Suitable for robes, clothing, or small bags. Satin finish stainless steel hook.



7312

DOUBLE ROBE HOOK

Two hooks, set apart at 90° on center, extend 2 $\frac{3}{8}$ " (60 mm) from wall or door. Suitable for robes, clothing, or small bags. Satin finish stainless steel.



7313

SOAP DISH WITH GLASS HOLDER

Clear glass holder has raised ribs to elevate soap slightly above surface to promote drying. May be removed for cleaning. All other parts of the unit are fabricated of satin finish stainless steel.

Overall Dimensions:

4 $\frac{1}{8}$ " DIA x 4 $\frac{7}{8}$ "
(110 DIA x 124 mm)



7314

SINGLE TOILET PAPER ROLL HOLDER

The toilet paper placed on this bail-type holder has unrestricted feed. Its design allows for easy replacement by maintenance or even guests. All exposed surfaces have a satin finish stainless steel. Paper bar is reversible to change handing.

Overall Dimensions:

5 $\frac{3}{8}$ " x 3 $\frac{3}{8}$ " x 2 $\frac{3}{16}$ "
(131 x 86 x 56 mm)



7317

COVERED WASTE RECEPTACLE

Freestanding covered garbage can. Lid opens by depressing foot pedal. Plastic pail with wire bail included. Bright finish stainless steel. Capacity: 2 gal. (7.6 L).

MODEL OPTION:

7317-S Satin stainless steel finish.

Overall Dimensions:

8 $\frac{3}{32}$ " DIA x 12 $\frac{1}{4}$ "
(210 DIA x 324 mm)



7314-H
SINGLE TOILET PAPER ROLL HOLDER WITH HOOD

Satin finish stainless steel hood. Hood adds weight for easy tear and also protects paper roll from water droplets.

Overall Dimensions:
 5¼" x 5" x 2⅜"
 (133 x 127 x 65 mm)



7315-H
DOUBLE TOILET PAPER ROLL HOLDER WITH HOOD

Double Toilet Paper Roll Holder with Hood is fabricated of stainless steel. All exposed surfaces have a satin finish. Roll holder bail is retained in post with concealed set screw. Hoods are captive on rod. Post is 22 gauge tubing with formed 18 gauge threaded bracket welded inside end.

Overall Dimensions:
 12½" x 3" x 5"
 (309 x 76 x 128 mm)



7316
SPARE TOILET PAPER HOLDER

Holds one roll of toilet paper. Extends 4" (102 mm) from wall. All exposed surfaces have a satin finish stainless steel.

Overall Dimensions:
 3⅝" DIA x 6⅞"
 (90 DIA x 167 mm)



NEW



0640
FRAMELESS MIRROR WITH LED BACKLIGHT

Frameless polished edge mirror with integral mounting frame and border LED halo lighting is made of ⅝" (4 mm) thick plate glass. Hard wired, concealed LED lighting system operates on 100/240 VAC 50/60 Hz and is turned on-off by an external wall switch (by others). Unit can be mounted horizontally or vertically without additional brackets or adaptations to mounting provisions.

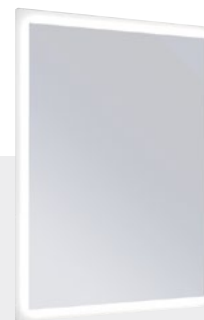

NEW



0641
FRAMELESS MIRROR WITH FROSTED BORDER AND LED BACKLIGHT

Frameless polished edge mirror with integral mounting frame and frosted glass border LED halo lighting is made of ⅝" (4 mm) thick plate glass. Hard wired, concealed LED lighting system operates on 100/240 VAC 50/60 Hz and is turned on-off by an external wall switch (by others). Unit can be mounted horizontally or vertically without additional brackets or adaptations to mounting provisions.



7387

SURFACE MOUNTED TOILET BRUSH AND HOLDER

Tube handle, round splash guard, and storage cylinder of this wall mounted unit are fabricated of satin finish stainless steel. Includes a drip cup at the bottom for easy cleaning. Brush is made of PVC with a polypropylene shaft. 15½" (394 mm) from bottom of base to top of handle and extends 5⅞" (131 mm) from wall. Allows for easy cleaning while maintaining an elegant washroom.

MODEL OPTION:

7388 Freestanding. 15" (381 mm) from bottom of base to top of handle.



0712

SURFACE-MOUNTED RETRACTABLE CLOTHES LINE

Polished stainless steel unit has spring actuated 72" (1829 mm) vinyl cord with white vinyl knob and locking nut to hold stretched line taut. Installs over bathtub or in shower.



7383

SURFACE MOUNTED TOWEL SHELF WITH HANGER ROD

Heavy-duty unit with ¾" diameter stainless steel tubing. Stainless steel setscrew provided on bottom perimeter of flanges to lock unit to mounting plates.

Overall Dimensions:

23⅞" x 3½" x 8⅛"
(600 x 89 x 227 mm)

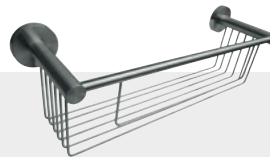

7381

SURFACE MOUNTED SUNDRIES SHELF

Stainless steel formed round wire construction and has 2⅝" (10 mm) diameter. Solid retainer cross bar as front rim. Satin finish on all visible surfaces. Stainless steel setscrew provided on bottom perimeter of flanges to lock unit to mounting plates.

Overall Dimensions:

12⅞" x 4⅞" x 3⅝"
(372 x 114 x 90 mm)

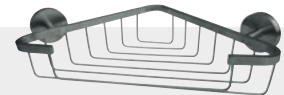

7322

SURFACE MOUNTED SOAP BASKET

Stainless steel formed round wire construction and fabricated with heavy gauge solid rectangular cross section formed bar top rim. Satin finish on all visible surfaces. Stainless steel setscrew provided on bottom perimeter of flanges to lock unit to mounting plates.

Overall Dimensions:

11⅝" x 2⅞" x 6½"
(291 x 58 x 165 mm)



7306

TOWEL RING

Designed for hand towels, this 7" DIA (178 mm) towel ring is formed from a $\frac{3}{8}$ " DIA (9.5 mm) satin finish stainless steel tube. Extends 2½" (64 mm) from wall.



1201-A

CURVED SHOWER CURTAIN ROD WITH MOUNTING BRACKETS

Fabricated of type 304 stainless steel. Tubing is 18 gauge, 1" DIA (25 mm) with a satin finish. Length is suitable for a 60" (1524 mm) wide enclosure either on opposite walls (-B) or across the face opening (-A) depending upon rod length chosen.

MODEL OPTION:

1201-B Curved shower curtain rod with mounting brackets for opposite walls.

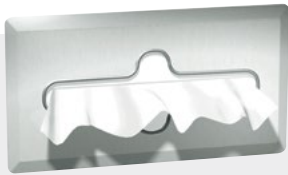

0259-SS

RECESSED FACIAL TISSUE DISPENSER

Dispenses 300 single-ply or 150 double-ply tissues. Faceplate constructed of stainless steel with satin finish.

Overall Dimensions:

11⅞" x 6⅞" x 2¼"
(302 x 162 x 57 mm)



7307-18

ROUND TOWEL BAR

Satin finish stainless steel tube and posts with round mounting brackets on ends. Extends 2½" (67 mm) from wall. 18" (457 mm) in length.

MODEL OPTION:

7307-24 Same as 7307-18, but 24" (610 mm) in length, $\frac{5}{8}$ " (16 mm) DIA.





Security Accessories

ASI offers many different items that are specifically designed for settings with high security requirements. Features include design for contraband detection and clothes hooks that release when excessively loaded to deter self-harm actions.

SHOWN: 128-1 BOOK SHELF/CLOTHES HOOK—FRONT MOUNTING



0198-MH
SAFE-DRI™ MENTAL HEALTH RECESSED
HIGH-SPEED HAND DRYER

Anti-ligature dryer designed for Behavioral Health environments—angled top, welded corners, and single tube exhaust prevent looping, tying off, wedging, and prying. Tamper-resistant 18 gauge stainless steel cover and flush pin-hex security screws. Available in 115-120 V and 208-240 V.

Unit Size: 12³/₄" x 15³/₄" x 5¹/₆"
 (320 x 400 x 140 mm)

Wall Opening: 12¹/₄" x 15⁵/₁₆" x 5¹/₄"
 (311 x 386 x 133 mm)

Decibel Level:
 66 dB-A @ 2M



128-1
BOOK SHELF/CLOTHES HOOK—FRONT MOUNT

Shelf and back plate are 14 gauge stainless steel with satin finish. Hooks are 12 gauge stainless steel, and back plate is 14 gauge stainless steel. Seams are welded and ground smooth. Hooks snap down for safety if excessively loaded. Unit has six holes through back for front mounting.

Overall Dimensions:
 18" x 11" x 8"
 (457 x 279 x 203 mm)



120

CLOTHES HOOK—FRONT MOUNT

Bracket 11 gauge, hook 7 gauge stainless steel with satin finish. If hook is excessively loaded, it will snap down for safety. Unit has four holes through flange for front mounting.

Overall Dimensions:

3" x 5" x 3 1/16"
(76 x 127 x 78 mm)

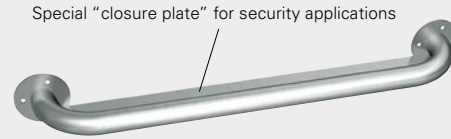

165

GRAB BAR

Tubing 18 gauge and flanges 1/8" (3 mm) thick stainless steel with satin finish. Closure plate is 1/8" (3 mm) thick. All welded construction. Unit has three holes through each flange for front mounting.

MODEL OPTIONS:

Front Mounted	Length
159	18" (457)
162	30" (762)
164	36" (914)
165	24" (610)
167	42" (1067)
169	48" (1219)



110-1

SQUARE RECESSED TOILET TISSUE HOLDER—REAR MOUNT

Fabricated of 14 gauge stainless steel with satin finish exterior, glass blasted satin finish interior 4" (102 mm) deep accommodates one standard toilet tissue roll. Flange is 7 1/8" (181 mm) square.

MODEL OPTION:

110-13 Front mounted holder.



123

SQUARE CLOTHES HOOK—FRONT MOUNT

Fabricated of 12 gauge type 304 stainless steel with a satin finish. Back plate is fabricated of 14 gauge stainless steel. If hook is excessively loaded, it will snap down for safety. Square shape. Unit has four holes for front mounting.

Overall Dimensions:

4 1/4" x 4 1/4" x 2 1/4"
(108 x 108 x 57 mm)

SECURITY ACCESSORIES



101-14 SECURITY FRAMED MIRROR— CHASE MOUNT

Frame 14 gauge stainless steel with satin finish, corners welded, and ground smooth. Unit provided with fiberboard backing and six "T" nuts welded on back for rear mounting. Specify wall thickness if greater than 6" (152 mm). 20 gauge stainless steel with #8 mirror polish.

Overall Dimensions:
12" x 16" x 5/8"
(305 x 406 x 16 mm)



105-14 SECURITY FRAMED MIRROR— FRONT MOUNT

Frame 14 gauge stainless steel with satin finish, corners welded, and ground smooth. Front mounting furnished with Torx® vandal-resistant 1/4"-20" x 2 (150 mm) machine screws. 20 gauge type 304 stainless steel with #8 mirror polish.

Overall Dimensions:
12" x 16" x 5/8"
(305 x 406 x 16 mm)



127 CLOTHES/TOWEL HOOK STRIP— FRONT MOUNT

Wall plate 14 gauge with beveled edges, 11 gauge brackets, and four 7 gauge hooks. Stainless steel with satin finish. Hooks snap down for safety if excessively loaded. Unit has six mounting holes through back for front mounting.

Overall Dimensions:
18" x 5 1/2" x 3"
(457 x 140 x 76 mm)



129 CLOTHES/TOWEL HOOK STRIP— FRONT MOUNT

Fabricated of 14 gauge stainless steel with satin finish. Hooks snap down for safety if excessively loaded. Six holes through back for front mounting.

Overall Dimensions:
18" x 5 1/2" x 2 1/4"
(457 x 140 x 57 mm)



140 RECESSED SOAP DISH— REAR MOUNT

Soap dish 16 gauge stainless steel with satin finish. One-piece drawn construction with beveled trim and embossments for air circulation and drainage. Unit has two "T" nuts welded on back for rear mounting.

Overall Dimensions:
7 3/8" x 6" x 3"
(187 x 152 x 76 mm)

Wall Opening:
6 1/2" x 5 x 3" min
(165 x 127 x 76 mm)



130 RECESSED SHELF— REAR MOUNT

Shelf 16 gauge type 304 stainless steel, corners welded, and ground smooth. 1" (25 mm) wide beveled satin finish trim. Interior glass blasted finish. Unit has four studs welded on back for rear mounting.

Overall Dimensions:
18" x 7" x 4"
(457 x 178 x 102 mm)

Wall Opening:
5 1/2" x 16 1/2"
(141 x 419 mm)



Waste Receptacles

ASI offers a wide range of waste receptacles available in fully recessed, semi-recessed, surface mounted, counter mounted, and freestanding with various capacities. Type 304 Stainless Steel fabrication with fully removable waste cans allows contents to be easily discarded for efficient ongoing maintenance and cleanliness.

SHOWN: 20458 ROVAL™ SEMI-RECESSED REMOVABLE WASTE RECEPTACLE



1000 TRADITIONAL™ CIRCULAR COUNTERTOP WASTE CHUTE

Provides waste deposit access to receptacle (not furnished) placed directly below chute; made of heavy gauge stainless steel with rolled flange and exposed surfaces that have satin finish.

MODEL OPTION:
1000A has a 9" (229 mm) outside diameter with a counter opening of 8 1/8" (206 mm) diameter.

Unit Size:	Counter Opening:
6 3/4" (171 mm) outside diameter	5 3/4" (146 mm) diameter



1003 TRADITIONAL™ COUNTERTOP MOUNTED WASTE RECEPTACLE

Push door is self-closing. A 12" x 12" x 12" (305 x 305 x 305 mm) waste receptacle is furnished to be placed directly below waste door on the vanity floor.

Unit Size:
14 1/4" x 10" x 3/32"
(362 x 254 x 2 mm)

Counter Opening:
8 3/4" x 12 1/2"
(222 x 318 mm)



0815
**FLOOR STANDING FOOT OPERATED
 WASTE RECEPTACLE**

Foot operated waste receptacle with satin finish stainless steel body and top. Connected with multi-staked piano hinge and features hemmed edges for safety. Capacity: 8 gal. (30.7 L).

Overall Dimensions:
 10³/₄" x 20¹⁵/₁₆" x 10"
 (273 x 531 x 254 mm)



0834-RB
**FREESTANDING 3-BIN
 RECYCLING STATION**

Freestanding 3-Bin Recycling Station constructed of an 18 gauge unified top and individual 22 gauge bins all of stainless steel. Bottoms of each receptacle are equipped with four (4) non-skid rubber feet. Top has shape-coordinated openings and permanent labels "TRASH," "BOTTLES," and "PAPER." Capacity: 42 gal. (159 L).

MODEL OPTION:
0839-RB has 57 gal. (216 L) capacity with 37⁷/₈" x 31⁷/₈" x 12¹/₂" (943 x 810 x 318 mm).

Overall Dimensions:
 37⁷/₈" x 31⁷/₈" x 12¹/₂"
 (943 x 810 x 318 mm)



NEW

0834
**TRADITIONAL™ FREESTANDING
 WASTE RECEPTACLE**

Fabricated of 22 gauge stainless steel; holds 14 gallons (54 L) of waste. Top is removable for easy maintenance, and bottom is equipped with four (4) non-skid rubber feet.

MODEL OPTION:
0839 has 19 gal. (72 L) capacity with 12³/₈" x 32" x 12¹/₂" (314 x 800 x 318 mm) dimensions.

Overall Dimensions:
 12³/₈" x 24" x 12¹/₂"
 (314 x 609 x 318 mm)



NEW

0834-T
**TRADITIONAL™ FREESTANDING
 WASTE RECEPTACLE WITH DUAL SWING TOP**

Fabricated of 22 gauge stainless steel; holds 14 gallons (54 L) of waste. Top has dual swing door and is removable for easy maintenance. Bottom is equipped with four (4) non-skid rubber feet.

MODEL OPTION:
0839-T has 19 gal. (72 L) capacity with 12³/₈" x 37¹/₄" x 12¹/₂" (314 x 946 x 318 mm) dimensions.

Overall Dimensions:
 12³/₈" x 29³/₄" x 12¹/₂"
 (314 x 756 x 318 mm)



0458
TRADITIONAL™ SEMI-RECESSED
WASTE RECEPTACLE

Stainless steel waste container locks into cabinet, removable for servicing. Fabricated of 22 gauge stainless steel.

MODEL OPTION:

0458-9 Surface mounted with a stainless steel collar.

Unit Size: 17¹/₄" x 30¹/₂" x 8¹/₄"
 (438 x 775 x 210 mm)
Wall Opening: 15³/₄" x 29" x (variable*)
 (400 x 737 mm)

*[0458 if 4" (102 mm) x 4" and 12 gals. (46 L); 0458-CX if 1/2" (13 mm) x 7¹/₂" (191 mm) and 12 gals. (46 L); 0458-DX if 8" (203 mm) x 4" (102 mm) and 18 gals. (68 L)]



7317
COVERED WASTE RECEPTACLE

Freestanding covered garbage can. Lid opens by depressing foot pedal. Plastic pail with wire bail included. Bright finish stainless steel. Capacity: 2 gal. (7.6 L).

MODEL OPTION:

7317-S Satin stainless steel finish.

Overall Dimensions:
 8³/₂" DIA x 12³/₄"
 (210 DIA x 324 mm)



0829
CORNER WASTE RECEPTACLE

Fabricated of 22 gauge stainless steel with hemmed top and bottom edges for safety; capacity of 16 gal. (60 L) of waste.

Overall Dimensions:
 15" x 23" x 14¹/₂"
 (381 x 584 x 368 mm)



20826
ROVAL™ SURFACE MOUNTED
WASTE RECEPTACLE

Receptacle front and sides fabricated of 20 gauge stainless steel with satin finish. 12.8 gal. (48.4 L) waste capacity.

MODEL OPTION:

20826-T Closed top, spring-loaded door. Capacity 12.8 gal. (48.4 L).

Overall Dimensions:
 15¹/₈" x 23" x 8¹/₂"
 (384 x 584 x 216 mm)



20458
**ROVAL™ SEMI-RECESSED REMOVABLE
WASTE RECEPTACLE**

Easy maintenance—removable 20 gauge stainless steel waste receptacle locks into cabinet with a tumbler lock for security. Capacity 11.2 gal. (42.6 L). Frame and cabinet fabricated of 22 gauge stainless steel with satin finish.

Unit Size:
17³/₈" x 27³/₄" x 8¹⁵/₁₆"
(441 x 705 x 227 mm)

Wall Opening:
15³/₄" x 26" x 3¹⁵/₁₆"
(400 x 660 x 100 mm)



0825
**TRADITIONAL™ SURFACE MOUNTED
WASTE RECEPTACLE**

Fabricated of 22 gauge stainless steel; holds 17 gal. (64 L) with top and bottom hemmed edges; interior hooks for liner.

MODEL OPTION:
0826 has 12 gal. (45.4 L) capacity with 15¹/₄" x 23" x 8" (387 x 584 x 203 mm) dimensions.

Overall Dimensions:
15³/₄" x 21⁷/₈" x 11³/₄"
(400 x 556 x 298 mm)



0827
**TRADITIONAL™ SURFACE MOUNTED
WASTE RECEPTACLE**

Fabricated of 22 gauge stainless steel with hemmed top and bottom edges for safety; capacity of 2 gal. (7.6 L) of waste.

Overall Dimensions:
10¹/₂" x 9" x 4³/₄"
(267 x 229 x 121 mm)



0828
**TRADITIONAL™ SURFACE MOUNTED
WASTE RECEPTACLE**

Fabricated of 22 gauge stainless steel with hemmed top and bottom edges for safety; holds 6.5 gal. (24.8 L) of waste.

Overall Dimensions:
14" x 18" x 6"
(356 x 457 x 152 mm)



6474

SIMPLICITY™ RECESSED WASTE RECEPTACLE

Stainless steel waste receptacle holds 12 gal. (46 L) of washroom waste materials. 18 gauge stainless steel door.

MODEL OPTIONS:

NEW 6474-41PC Matte Black

6474-2 Semi-recessed with a stainless steel collar.

NEW 6474-2-41PC Matte Black.

Unit Size:

17¹/₄" x 40" x 6³/₄"
(438 x 1016 x 171 mm)

Wall Opening:

15³/₄" x 38¹/₂" x 6¹/₄"
(400 x 978 x 159 mm)



6474-00

SIMPLICITY™ RECESSED WASTE RECEPTACLE

Stainless steel waste receptacle holds 12 gal. (46 L) of washroom waste materials. 18 gauge stainless steel door.

MODEL OPTION:

6474-2 Semi-recessed with a stainless steel collar.

Unit Size:

17¹/₄" x 40" x 6³/₄"
(438 x 1016 x 166 mm)

Finished Wall Opening*:

17⁷/₁₆" x 40¹/₁₆" x 6¹/₁₆"
(440 x 1018 x 170 mm)



04733

TRADITIONAL™ RECESSED WASTE RECEPTACLE

Self-closing panel covers the receptacle opening, removable 3 gal. (11.4 L) stainless steel waste receptacle. Fabricated of 22 gauge stainless steel.

Unit Size:

14¹/₄" x 28" x 4¹/₂"
(362 x 711 x 114 mm)

Wall Opening:

12³/₄" x 26¹/₂" x 4"
(324 x 673 x 102 mm)



6459

SIMPLICITY™ RECESSED WASTE RECEPTACLE

Stainless steel waste receptacle holds 4 gal. (15 L) of waste and has a self-closing panel that covers its opening. 18 gauge stainless steel door.

Unit Size:

14¹/₄" x 28" x 4¹/₂"
(362 x 711 x 114 mm)

Wall Opening:

12³/₄" x 26¹/₂" x 4¹/₄"
(324 x 673 x 108 mm)

WHO WE ARE

Only ASI Group designs, engineers, and manufactures fully integrated washroom accessories, partitions, lockers, and visual display products from one source.

The ASI Group is known for innovative products, speed to market, and the widest offering of materials and products

in the industry. Our family of companies work together with one mission in mind—“To make our customers successful by providing value that exceeds price and an excellent service experience.”



1 **Port House**
Architect: Zaha Hadid Architects
ASI Alpaco™ Partitions



2 **Perimeter College**
Architect: Teeple Architects
ASI Visual Display Products





**WE ARE LASER FOCUSED ON DELIVERING EXACTLY WHAT YOU NEED—
WHERE AND WHEN YOU NEED IT.**

With operating units and offices in the USA, Canada, Australia, Belgium, UK, Middle East, and Mexico, along with sales in more than 50 countries, our ability to serve is not limited by geography.

Our broad scope helps meet the needs of healthcare, education, office, and retail buildings, as well as airports, stadiums, government offices, cultural centers, and hotel/restaurant operations.

SALES IN OVER 50 COUNTRIES

385+ DOMESTIC AND INTERNATIONAL SALES REPRESENTATIVES

1,000+ HIGHLY SKILLED EMPLOYEES

>1.3 MILLION SQ. FT. MANUFACTURING & OFFICE FACILITIES



2

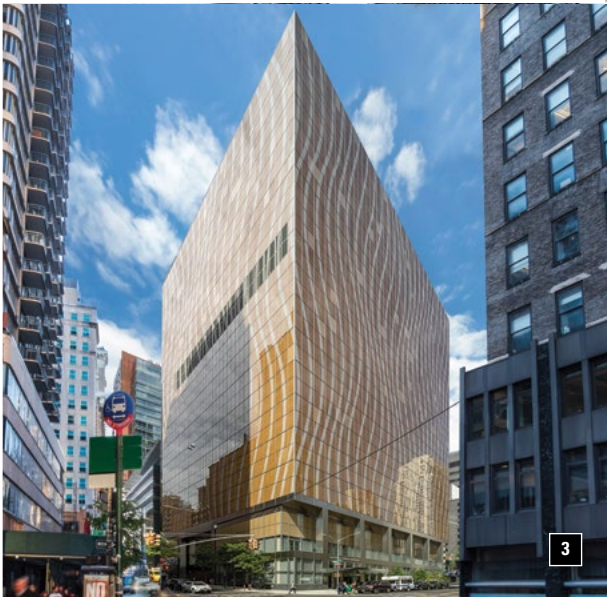

3



4

3 **New York-Presbyterian David H. Koch Center**
Architect: HOK Architects
HDPE Plastic Z lockers,
Phenolic Z lockers,
Metal Z lockers, and
Stainless Steel Accessories
and Partitions



4 **U.S. Bank Stadium**
Architect: HKS
Washroom Accessories and
Solid Plastic Partitions



**SANITIZING
(NO) TOUCH
ACCESSORIES**

Model	Page
0334-B	59/64
0334-S	59/64
0335-B	59/64
0335-S	59/64
0360	58/65
0361	61/65
0362	58/65
0362-41	16/58/65
0502	66
20364	30/61/64/66
20365	30/61/66

**SECURITY
ACCESSORIES**

Model	Page
0198-MH	36/52/107/114
101-14	116
105-14	116
110-1	115
110-13	85/115
120	115
123	115
127	116
128-1	114
129	116
130	116
140	116
159	115
162	115
164	115
165	115
167	115
169	115

SHELVES

Model	Page
0412	99
0690	98
0692	98/99
0694	98/99
0698	99
20692	31/98/99

**SHOWER/TUB
ACCESSORIES**

Model	Page
0010	90
0398	88
0399	88
0400	88
0401	88
0410-Z	88
1200-SHU	90
1200-V	90
1201-A	88/89/113
1201-B	89/113
1204	89
1214	89
1224	89
7404-B	89
7404-S	89
7410-B	89
7410-S	89
8202	91/103

8203	90/103
8204	90
8205-L	91
8205-R	91
8206-L	91
8206-R	91
8206-SC	103
8206-SC-L	91
8206-SC-R	91
8207	90
8208	103
8208-L	90
8208-R	90
8209	91
8358	90

SOAP DISPENSERS

Model	Page
0326	62
0332	60
0332-C	60
0332-CD	60
0332-D	60
0334-B	59/64
0334-S	59/64
0335-B	59/64
0335-S	59/64
0336	60
0336-D	60
0338	59
0339	59
0345	16/62
0345-41	16/62
0347	16/62
0347-41	16/62
0387	57
0388	57
0388-1A	57
0388-1AC	57
0389	57
0389-1A	57
0389-1AC	56/57
0349	105
0350	105
0357	62
0359	62
0360	58/65
0361	61/65
0362	58/65
0362-41	16/58/65
0390	57
0390-1A	57
0390-1A-41	57
0390-1AC	57
0390-1AC-41	57
0390-6-1A	57
0390-6-1A-41	57
0390-6-1AC	57
0390-6-1AC-41	57
0390-ARK	57
0390-BR	57
0390-R	57
0391-1A	57
0391-1A-41	57
0391-1AC	57
0391-1AC-41	57
0391-6-1A	57
0391-6-1A-41	57

0391-6-1AC	57
0391-6-1AC-41	57
0393-1A	57
0393-1A-41	57
0393-1AC	57
0393-1AC-41	57
0393-6-1A	57
0393-6-1A-41	57
0393-6-1AC	57
0393-6-1AC-41	57
0393-R	57
0394-1A	57
0394-1A-41	57
0394-1AC	56/57
0394-1AC-41	17/56/57
0394-6-1A	57
0394-6-1A-41	57
0394-6-1AC	57
0394-6-1AC-41	57
0397	58
0397-41	58
0397-1A	57
0397-1AC	56/57
0397-1A-41	57
0397-1AC-41	17/57/58
0661-1	22/55/63/70
0661-2	22/55/63/70
0661-T	20/22/55/63/70
0663-1	23/55/63/70
0663-2	23/55/63/70
0663-T	23/55/63/70
20333	60
20334	60
20363	30/61
20364	30/61/64/66
20365	30/61/66
5001-SS	61
9343	30/62
9343-41	14/16/30/62

**SPECIALTY
ACCESSORIES**

Model	Page
0002-SM	77
0258-SS	78
0259-SS	79/113
0481	79
0481-HC	79
04813	79
04813-HC	79
0482	79
04822	79
04823	79
048234	79
0483	79
04833	79
0484	79
0484-HC	79
0485	79
0486	79
0487-L	79
0487-L-9	79
0487-R	79
0487-R-9	79
0503	78/106
0504	78/106
0712	77/112
0714	76

0719	76
0721-Z	77
0735-Z	77
0740-Z	76
0745-Z	76
0751	77
0751-A	77
0755-SS	78
0755-Z	78
0760-Z	78
0785-Z	76/77
7301-B	77
7301-S	77
7310-B	78
7310-S	78
7311-B	78
7320	77
7335	77
7340	76
7340-41	17/76
7345	76
7355	78
7355-B	78
7355-S	78
7355-24-41	17/78
7382	77
7385	76
7385-41	17/76
8425	76

**TOILET TISSUE
DISPENSERS**

Model	Page
0030	81/82
0030-41	19/82
0031	81/82
0032	81/82
0039	83
0040	83
0042	83
0042-41	14/16/83
0263-1	84
0264-1	84
0266	84
0267	84
0402-Z	81/85
0477	85
0477-SM	85
0477-SM-41	15/85
0697-GAL	81/84
0705-Z	81/85
0710	84
0715	84
110-13	85/115
20030	29/81
20031	29/81
20477-SM	29/85
6477	39
7303	85
7304-41	16
7305-2B	84
7305-2S	84
7305-B	84
7305-S	84
7305-41	16/84
7305-2-41	16
7402	83
7402-H	83

74022	83
74022-H	80/83
7403	84
7403-B	84
7403-S	84
R-002	81
R-003	81
R-005	81
R-009	81

**WASTE
RECEPTACLES**

Model	Page
0458	46/119
0458-9	46/119
04733	46/121
0815	106/118
0825	48/120
0826	48/120
0827	48/120
0828	48/120
0829	48/119
0834	48/118
0834-RB	118
0834-T	48/118
0839	48/118
0839-41	19
0839-RB	118
0839-T	48/118
1000	49/117
1000A	49/117
1003	49/117
20458	28/117/120
20826	28/119
20826-T	28/119
6459	38/121
64672-00	12/54
64672-2	12/35/54
64672-41PC	15/35
6467-9-41PC	15/34
6474	12/38/121
6474-00	12/121
6474-41	12
6474-2	38/121
6474-41PC	15/38/121
6474-2-41PC	15/38/121
7317	110/119
7317-S	110/119

INDEX OF PRODUCTS BY MODEL NUMBER

MODEL	PAGE	MODEL	PAGE	MODEL	PAGE	MODEL	PAGE	MODEL	PAGE
0002-SM	77	0388-1AC	57	045210AC-6	46	048234	79	0712	77/112
0010	90	0389	57	045210AC-9	46	0483	79	0714	76
0030	81/82	0389-1A	57	0457	46	04833	79	0715	84
0030-41	19/82	0389-1AC	56/57	0457-9	46	0484	79	0719	76
0031	81/82	0390	57	0458	46/119	0484-HC	79	0721-Z	77
0032	81/82	0390-1A	57	0458-9	46/119	0485	79	0735-Z	77
0039	83	0390-1A-41	57	0462-AD	42	0486	79	0740-Z	76
0040	83	0390-1AC	57	0462-AD-9	42	0487-L	79	0745-Z	76
0042	83	0390-1AC-41	57	0464	73	0487-L-9	79	0751	77
0042-41	14/16/83	0390-6-1A	57	0467	44	0487-R	79	0751-A	77
0135-1	53	0390-6-1A-41	57	0467-2	44	0487-R-9	79	0755-SS	78
0184	53	0390-6-1AC	57	0467-9	44	0501-X	107	0755-Z	78
0185	53	0390-6-1AC-41	57	0468	72/73	0501-1	107	0760-Z	78
0192	53	0390-ARK	57	0468-2	73	0501-2	107	0785-Z	76/77
0196-00	50/51/53	0390-BR	57	04684	73	0501-3	107	0815	106/118
0196-41	17/50/51/53	0390-R	57	0469	40/42	0501-4	102/107	0825	48/120
0196-93	50/51/53	0391-1A	57	0469-2	42	0502	66	0826	48/120
0196-1-41	17/53	0391-1A-41	57	0469-9	42	0503	78/106	0827	48/120
0196-2-41	17/53	0391-1AC	57	0469-BL	42	0504	78/106	0828	48/120
0197	52	0391-1AC-41	57	04692	43	0511	107	0829	48/119
0198-MH	36/52/107/114	0391-6-1A	57	04692-6	43	0512	107	0834	48/118
0199-1-41	19/52	0391-6-1A-41	57	04692-9	43	0515	105	0834-RB	118
0199-2-41	19/52	0391-6-1AC	57	04692A	43	0533-1	101/104	0834-T	48/118
0210	47	0391-6-1AC-41	57	04692A-6	43	0533-2	101/104	0839	48/118
0210-41	14/15/47	0393-1A	57	04692A-9	43	0533-3	101/104	0839-41	19
0215	47	0393-1A-41	57	04692AC	43	0533-4	101/104	0839-RB	118
0245-SS	47	0393-1AC	57	04692AC-6	43	0533 SERIES	101/104	0839-T	48/118
0258-SS	78	0393-1AC-41	57	04692AC-9	43	0535	67/69	0852	75
0259-SS	79/113	0393-6-1A	57	046921	45	0537	69	0852-41	18
0263-1	84	0393-6-1A-41	57	046921-6	45	0548	106	0864	73
0264-1	84	0393-6-1AC	57	046921-9	45	0548-9	106	0864-41	18
0266	84	0393-6-1AC-41	57	046921A	45	0551	107	0952	104
0267	84	0393-R	57	046921A-6	45	0556	107	0952-B	104
0326	62	0394-1A	57	046921A-9	45	0557	107	0953	104
0332	60	0394-1A-41	57	046921AC	45	0558-1	107	101-14	116
0332-C	60	0394-1AC	56/57	046921AC-6	45	0559	107	105-14	116
0332-CD	60	0394-1AC-41	17/56/57	046921AC-9	45	0600	68/69	110-1	115
0332-D	60	0394-6-1A	57	046924	45	0600-T	68/69	110-13	85/115
0334-B	59/64	0394-6-1A-41	57	046924-9	45	0600-1836-41	16	120	115
0334-S	59/64	0394-6-1AC	57	046926	44	0600-2436-41	16	123	115
0335-B	59/64	0394-6-1AC-41	57	04697	43	0600-41	16/68	127	116
0335-S	59/64	0397	58	04697-4	43	0605	67/69	128-1	114
0336	60	0397-41	58	04697-9	43	0620	67/69	129	116
0336-D	60	0397-1A	57	04697-BL	43	0625	67/69	130	116
0338	59	0397-1AC	56/57	0472	74	0640	68/69/111	140	116
0339	59	0397-1A-41	57	0472-1	74	0641	68/69/111	159	115
0345	16/62	0397-1AC-41	17/57/58	0473	74	0661-1	22/55/63/70	162	115
0345-41	16/62	0398	88	0473-1	74	0661-2	22/55/63/70	164	115
0347	16/62	0399	88	0473-A	74	0661-T	20/22/55/63/70	165	115
0347-41	16/62	0400	88	0473-1A	74	0661-FM-14	22/71	167	115
0349	105	0401	88	04733	46/121	0661-FM-23	22/71	169	115
0350	105	0402-Z	81/85	0477	85	0663-1	23/55/63/70	1000	49/117
0357	62	0410-Z	88	0477-SM	85	0663-2	23/55/63/70	1000A	49/117
0359	62	0412	99	0477-SM-41	15/85	0663-T	23/55/63/70	1001	49
0360	58/65	0439	47	0481	79	0690	98	1002	49
0361	61/65	0452	46	0481-HC	79	0692	98/99	1003	49/117
0362	58/65	0452-9	46	04813	79	0694	98/99	1200-SHU	90
0362-41	16/58/65	045210A	46	04813-HC	79	0697-GAL	81/84	1200-V	90
0387	57	045210A-6	46	0482	79	0698	99	1201-A	88/89/113
0388	57	045210A-9	46	04822	79	0705-Z	81/85	1201-B	89/113
0388-1A	57	045210AC	46	04823	79	0710	84	1204	89

MODEL	PAGE	MODEL	PAGE	MODEL	PAGE	MODEL	PAGE	MODEL	PAGE
1214	89	3700-W	86	64672-1-41	12/54	7314-H	111	8425	76
1224	89	3800 SERIES	86	64672	35	7315-H	111	8522	47
1306	101	3800-41	19/86	64672-00	12/54	7316	111	8523A	47
1307-3	100	3800-AW SERIES	86/106	64672-1	12/35/54	7317	110/119	8523AC	47
1307-4	100	3800-W	86	64672-2	12/35/54	7317-S	110/119	9012	94
1307-5	100	3801-41	17	64672-2-00	12/54	7320	77	9013	30/92/94
1307-6	100	3801-18-41	17/86	64672-2-41	12/54	7322	112	9013-9	30/94
1308-3	100	3801-24-41	17/86	64676	34	7335	77	9014	94
1308-4	100	3801-36-41	17/86	64676-2	34	7340	76	9014-41	18/94
1315-3	101	3801-42-41	17/86	64676-9	34	7340-41	17/76	9015	95
1315-4	101	3801-18AW	86/106	6468	39/73	7345	76	9017	95
1315-6	101	3801-24AW	86/106	64684	39/73	7355	78	9017-9	95
20030	29/81	3801-36AW	86/106	646924A	35	7355-B	78	9018	96
20031	29/81	3801-42AW	86/106	646924A-9	35	7355-S	78	9018-41	18/97
20199	31/52	3801-48AW	86/106	646924AC	35	7355-24-41	17/78	9018-9	96
20200	31	3874	87	646924AC-9	35	7381	112	9018-9-41	97
20210	29	3874-M2337	87	64696	37	7382	77	9020	95
20333	60	5001-SS	61	64696-6	37	7383	108/112	9343	30/62
20334	60	6452	38	64696-9	37	7385	76	9343-41	14/16/30/62
20363	30/61	6452-9	38	64696A	12/37	7385-41	17/76	R-002	81
20364	30/61/64/66	645210A	13/37	64696A-6	37	7387	112	R-003	81
20365	30/61/66	645210A-6	37	64696A-9	37	7388	112	R-005	81
20452	29	645210A-9	37	64696A-00	12	7402	83	R-009	81
204523A	29	645210A-00	13	64696A-41	12	7402-H	83		
204523A-6	29	645210A-41	13	64696AC	12/37	74022	83		
204523A-9	29	645210AC	13/37	64696AC-6	37	74022-H	80/83		
204523AC	29	645210AC-6	37	64696AC-9	37	7403	84		
204523AC-6	29	645210AC-9	37	64696AC-00	12	7403-B	84		
204523AC-9	29	645210AC-00	13	64696AC-41	12	7403-S	84		
20458	28/117/120	645210AC-41	13	6471	39/75	7404-B	89		
204623	26	645224-6	36	6474	12/38/121	7404-S	89		
204623-9	26	645224-9	36	6474-00	12/121	7410-B	89		
204684	28/73	645224A-6	36	6474-2	38/121	7410-S	89		
204684-9	28/73	645224AC	36	6474-2-41PC	15/38/121	8026	67/69		
20469	24/26	645224AC-6	36	6474-41	12	8154	104		
20469-9	26	645224AC-9	36	6474-41PC	15/38/121	8155	104		
204692A	27	6457	12/38	6477	39	8156	104		
204692A-6	27	6457-00	12	68523A	39	8165	47		
204692A-9	27	6457-41	12	68523A-4	39	8202	91/103		
204692AC	27	6459	38/121	68523AC	39	8203	90/103		
204692AC-6	27	6462	13/34	68523AC-4	39	8204	90		
204692AC-9	27	6462-2	34	7301-B	77	8205-L	91		
2046921A	27	6462-9	34	7301-S	77	8205-R	91		
2046921A-6	27	6462-00	13	7303	85	8206-L	91		
2046921A-9	27	6462-41	10/13	7304-41	16	8206-R	91		
2046921AC	27	64623	13/36	7305-2B	84	8206-SC	103		
2046921AC-6	27	64623-9	36	7305-2S	84	8206-SC-L	91		
2046921AC-9	27	64623-00	13	7305-B	84	8206-SC-R	91		
20470	28/75	64623-41	13	7305-S	84	8207	90		
20477-SM	29/85	64623-41PC	15/36	7305-41	16/84	8208	103		
20650	31/67/67/68/69	64623-9-41PC	15/36	7305-2-41	16	8208-L	90		
20650-B	69	6467	13/32/34	7306	113	8208-R	90		
20655	31/68/69	6467-41PC	15/34	7307-18	113	8209	91		
20655-B	69	6467-9	34	7307-24	113	8215-3	101		
20692	31/98/99	6467-9-41PC	15/34	7308	110	8215-4	101		
20826	28/119	6467-00	13	7310-B	78	8215-5	101		
20826-T	28/119	6467-41	13	7310-S	78	8287	68		
20852	28/75	64672	35	7311-B	78	8338	105		
3400 SERIES	86	64672-41PC	15/35	7312	110	8339	105		
3500 SERIES	86	64672-1	12/35/54	7313	110	8340	105		
3700 SERIES	86	64672-1-00	12/54	7314	110	8358	90		



441 Saw Mill River Rd.
Yonkers, NY 10701
Phone: 914.476.9000
Fax: 914.476.0688
Web: americanspecialties.com

© 2024 American Specialties, Inc., an ASI Group Company